

# owner's manual

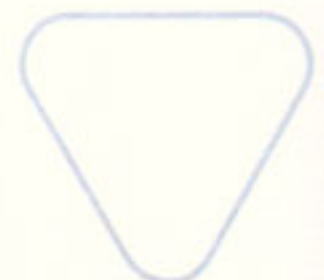

**infinity**™  
HARNESSES & CONTAINER SYSTEM

**velocity**™  
SPORTS  
EQUIPMENT

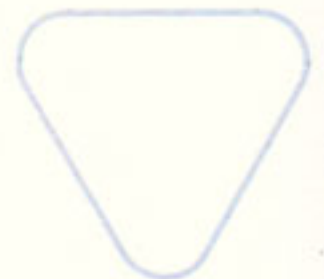

10305 139th St. Ct. E. - Unit D-1  
Puyallup, WA 98374  
V: 253.445.8790 F: 253.445.8792  
email: [info@VelocityRigs.com](mailto:info@VelocityRigs.com) - [www.VelocityRigs.com](http://www.VelocityRigs.com)



# Infinity Owner's Manual

Revised February 1999

This manual applies only to Infinity harness and container systems with a serial number of 6000 and higher.

**Serial Number:** \_\_\_\_\_

**Date of Manufacture:** \_\_\_\_\_

## WARNING:

Skydiving is a hazardous activity, which may result in serious injury or death. Parachutes do not always open properly, and skydiving equipment can fail, even if all possible precautions are taken by the user, the equipment manufacturer, and everyone else involved with the jump. If you use your *Infinity* or allow it to be used by someone else, you are acknowledging the risks of skydiving and accepting the fact that the *Infinity* or its components may malfunction.

## DISCLAIMER - NO WARRANTY

Because of the unavoidable dangers involved with the use of this and all parachute equipment, Velocity Sports Equipment (including but not limited to its owners, officers, staff, and employees), makes **NO WARRANTIES** of any kind, either expressed or implied. All equipment manufactured by Velocity Sports Equipment is sold with all faults and without any Warranty of merchantability or of fitness for any purpose. Velocity Sports Equipment also disclaims any liability in tort for damages, direct or consequential, including personal injuries resulting from a defect in design, material, workmanship, servicing, assembly, packing, or manufacture, whether caused by negligence on the part of Velocity Sports Equipment or otherwise. By using this equipment or allowing it to be used by others, the Buyer waives any liability of Velocity Sports Equipment for personal injuries or other damages arising from such use.

If the Buyer declines to waive liability on the part of Velocity Sports Equipment, the Buyer may obtain a full refund of the purchase price by returning the equipment, **unused**, within thirty (30) days of the original date of purchase, with a letter explaining the cause for return.

### Velocity Sports Equipment

10305 139<sup>th</sup> St. Ct. E.

Unit D-1

Puyallup, WA 98374

Phone: 253-445-8790 Fax: 253-445-8792

[www.velocityrigs.com](http://www.velocityrigs.com)

## TABLE OF CONTENTS

INTRODUCTION .....	PAGE 3
LIMITATIONS .....	PAGE 4
TO THE OWNER .....	PAGE 5
EQUIPMENT MAINTENANCE.....	PAGE 6
CONTAINER VOLUME CHART.....	PAGE 7

### THE MAIN CONTAINER:

ASSEMBLY .....	PAGE 8
PACKING.....	PAGE 9
HAND-DEPLOYED MAIN PILOT CHUTE.....	PAGE 14
PULL-OUT MAIN PILOT CHUTE .....	PAGE 15

### THE RESERVE CONTAINER:

ASSEMBLY.....	PAGE 17
PACKING: ROUND.....	PAGE 18
PACKING: SQUARE.....	PAGE 24
CYPRES AAD .....	PAGE 36
RSL (RESERVE SUPPLEMENTAL LANYARD).....	PAGE 37
3-RING OPERATION AND MAINTENANCE .....	PAGE 40

## **INTRODUCTION**

Thank you for choosing the new *Infinity* by Velocity Sports Equipment. We are sure you will appreciate the look and feel of our rig, as well as our quality workmanship. In addition, we have made some changes that we are sure you'll enjoy. These include:

- ❖ More secure riser and pin protection
- ❖ Main bridle protection
- ❖ Riser covers which are integrated into the reserve container
- ❖ Velcro-free RSL
- ❖ New better launching reserve pilot chute with higher drag
- ❖ Improved freebag stow-pocket design to reduce line wear
- ❖ More padding in the leg pads
- ❖ Improved appearance and design

Please take the time to familiarize yourself with this owner's manual, even if you have owned or jumped an *Infinity* before. And please keep this owner's manual on hand; your rigger may need it to service your new *Infinity*.

If you need anything, or have any questions or comments, please contact us at Velocity Sports Equipment: 10305 139<sup>th</sup> St. Ct. E., Unit D-1 Puyallup, WA 98374; Phone: 253-445-8790; Fax: 253-445-8792. We are open between 7:00 AM and 5:30 PM Pacific time, Monday-Thursday.

## LIMITATIONS OF EQUIPMENT

*INFINITY* Harness/Container Systems are manufactured with FAA authorization under TSO-C23c Category B of SAE Aerospace Standard AS-8015A. The use of the *INFINITY* is limited to a maximum weight of 254 lbs. (115 kg) and a maximum airspeed of 150 knots. Further weight and speed limitations are imposed by Velocity Sports Equipment, Inc. based upon the maximum recommended or approved weight and speed limitations defined by the manufacturer of any and all attached components (i.e. main or reserve canopies).

It is the responsibility of the individual jumper to familiarize him or herself with the operation, maintenance, and limitations of all components of the assembled *INFINITY* harness/container system. Any questions or concerns regarding the compatibility, assembly, packing, maintenance, or use should be directed to an FAA certificated parachute rigger, instructor, or the manufacturer as applicable.

## TO THE OWNER

Your new rig has been crafted from the finest materials available. Treat it well, and it will last a lifetime of jumps. Keep it out of the sun, and avoid dirt and stains. Store it away from oils, moisture, acids, abrasives, etc. Inspect it frequently for wear or damage.

To clean your gear occasionally of heavy soil, soak it in cool water in a mild, non-detergent soap solution (such as Woolite), and brush it clean.

When it is time to assemble or repack your reserve, choose a rigger you know and trust, one who will let you watch. You (and your rigger) will appreciate the ease with which the *INFINITY* container closes around your reserve, allowing a clean launch pad for your pilot chute. You will also gain a better understanding of your reserve system and how it works.

The *INFINITY* harness/container system is a custom made sport rig. It is fully approved under FAA TSO C23c, and is custom built to fit specific volume canopies. Check the tag on the packing data card pocket (located in a pocket behind the left ring cover) to find out what size reserve canopy will fit in the reserve container. Velocity Sports Equipment recommends a properly organized P.R.O. pack for the reserve, for optimum bulk distribution.

Your new *INFINITY* comes with all parts required for assembly with your reserve and main canopies. The main risers with toggle system are provided with either 3-ring or mini 3-ring releases. Although the size differs, they operate in the same manner. Your rig is also supplied with a reserve bridle and pilot chute, or a reserve free-bag, pilot chute, toggles, and guide rings (for square reserve canopies), a main pilot chute, main bridle, and main deployment bag.

The *INFINITY* comes with a reserve ripcord. When activated, it should be pulled hard to full extension of the user's arm. Also provided is a main canopy jettison handle (cutaway handle). It too, should be pulled to full extension of user's arm when used. Housings for both reserve activation and main jettison cables are provided and tacked in place at the factory. These tacks should be checked periodically to be certain they are secure.

The *INFINITY* is manufactured with the CYPRES set up installed. Consult the CYPRES manuals for proper installation and operation.

Keep this manual with your *INFINITY* for availability to your rigger when required.

## EQUIPMENT MAINTENANCE

### **Requirements for maintenance per FAR 105.43:**

- A. A certificated parachute rigger or the person making the parachute jump must have packed the main parachute within 120 days before the date of its use.
- B. A certificated, **BACK** rated FAA Senior or Master parachute rigger must have packed the auxiliary/reserve parachute within 120 days before the date of use if made of synthetic fiber; or 60 days before the date of use if made of silk, pongee, or other natural fibers.

### **USER MAINTENANCE:**

Prior to each jump the jumper should examine the general condition of the *INFINITY* Harness/Container System. Any questions or concerns should be directed to the proper authority (i.e.: rigger, instructor, or the manufacturer). The following is a list of specific items which should be examined prior to the use of this equipment.

1. Check for the proper seating of the main container pin, examine the integrity of the closing loop and check the main bridle for proper routing and general condition.
2. Check the reserve pin to assure proper seating and straightness, examine the closing loops for wear, and assure the outer flap is secure.
3. Check all visible harness and container stitching.
4. Check all housings for excessive wear, dents, and proper tacking.
5. Examine all velcro to be sure it is clean and holds securely.
6. Check the reserve ripcord for freedom of movement in housing and the secure seating of the handle in the velcro pocket.
7. Check the hardware for operation and for cracks or chips in the plating.
8. Assure the proper assembly of the Booth 3-Ring Release System (refer to page 41).
9. Verify that the main pilotchute is fully inserted in its pocket and that the handle is easily accessible.
10. Assure the RSL is connected per your preference. (Note: The installation or use of the RSL is encouraged, but not required.)

***INFINITY***  
**CONTAINER COMPATIBILITY CHART**

<u>CONTAINER SIZES</u>	<u>RESERVE SIZE RANGE SQUARE FEET</u>	<u>MAIN SIZE RANGE SQUARE FEET</u>
I-10TSN	99-109	9 cell, 83-92
I-11TSN	99-109	9 cell, 89-99
I-12TSN	99-109	9 cell, 97-109
I-10SN	113-120	9 cell, 89-99
I-11SN	113-120	9 cell, 97-109
I-12SN	113-120	9 cell, 107-120
I-13SN	113-120	9 cell, 120-135
I-21	126-135	9 cell, 97-109
I-22	126-135	9 cell, 107-120
I-23	126-135	9 cell, 120-135
I-24	126-135	9 cell, 135-150
I-32	143-150	9 cell, 120-135
I-33	143-150	9 cell, 135-150
I-34	143-150	9 cell, 150-170
I-43	160-181	9 cell, 135-150
I-44	160-181	9 cell, 150-170
I-45	160-181	9 cell, 170-190
I-46	160-181	9 cell, 190-210
I-47	160-181	9 cell, 230-260
I-48	160-181	9 cell, 260-280
I-54	193-218	9 cell, 150-170
I-54W	193-218	9 cell, 190-210
I-55	193-218	9 cell, 170-190
I-55W	193-218	9 cell, 210-230
I-56	193-218	9 cell, 190-210
I-57	193-218	9 cell, 210-230
I-65N	218-228	9 cell, 170-190
I-66N	218-228	9 cell, 190-210
I-68N	218-228	9 cell, 210-230
I-69NW	218-228	9 cell, 260-300
I-74N	235-249	9 cell, 190-210



## **ASSEMBLING THE MAIN CONTAINER**

1. Lay out the main parachute, flake the canopy, and check the lines for straightness and continuity.
2. When the lines check out, attach the connector links to the risers in the correct manner (nose of canopy on front risers, tail on rear risers, connector link barrels to the inside, long side down).
3. Run the steering lines through the guide rings on the rear risers.
4. Attach the toggles to the steering lines according to the manufacturer's instructions.
5. Attach the right riser to the right side of harness; attach the left riser to the left side of harness.
6. For a standard pilot chute and bridle, run the bridle loop through the grommet at the top of bag, (mouth of bag toward canopy), with the bag-stop positioned on the outside of the bag. Thread the bridle through the ring at the top of the canopy (or nylon loop if provided with canopy), and thread it back through the grommet at top of bag.
7. Thread the pilot chute through the loop in the bridle and pull to secure.
8. For kill-line pilot chute assembly, consult the pilot chute owner's manual included with the pilot chute.
9. Install the retainer bands on the bag.
10. The main parachute is now ready to pack according to manufacturer's instructions.

**NOTE: IT IS RECOMMENDED THAT THE PROPER ASSEMBLY BE INSPECTED AND VERIFIED BY A CERTIFICATED PARACHUTE RIGGER.**

## PACKING INSTRUCTIONS FOR THE MAIN CONTAINER

1. Flake and fold the canopy according to the manufacturer's instructions or recommendations. Note: Fold the canopy narrow enough to fit into the deployment bag and wide enough to completely fill the corners of the bag.
2. Stack the canopy on itself so that it is approximately the same depth as the bag.
3. Slide the stacked canopy into the deployment bag, assuring that the corners of the bag are completely filled.
4. Close the deployment bag, and place the first stows into the retainer bands after passing them through the grommets on the edge of the locking flap. (There may be 2 or 4 grommets.)
5. Stow the remaining suspension line along the bottom of the bag in the retainer bands (side to side). The stows should be 2 ½ inches long. Leave about 15 to 18 inches of line unstowed.
6. Pull the pilotchute bridle out of the bag until you seat the metal ring against the grommet. **(IF A KILL-LINE COLLAPSIBLE IS USED, VERIFY THAT IT IS COCKED!)**

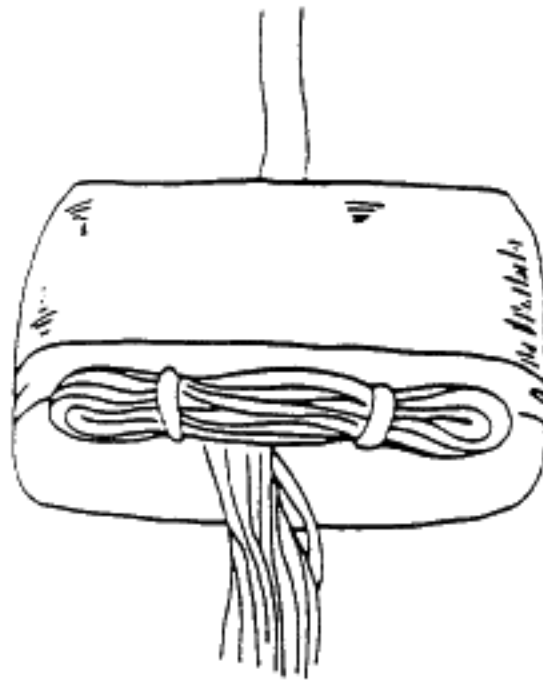

7. Stow the risers under the riser cover flaps on the reserve container, laying them side by side. Place the bag in the container (lines down). Fill in the corners. If your *INFINITY* has come equipped with a pull-out pilot chute, now is the time to stow the bridle and pilot chute in the container on top of bag and insert pilot chute handle in the pocket provided.

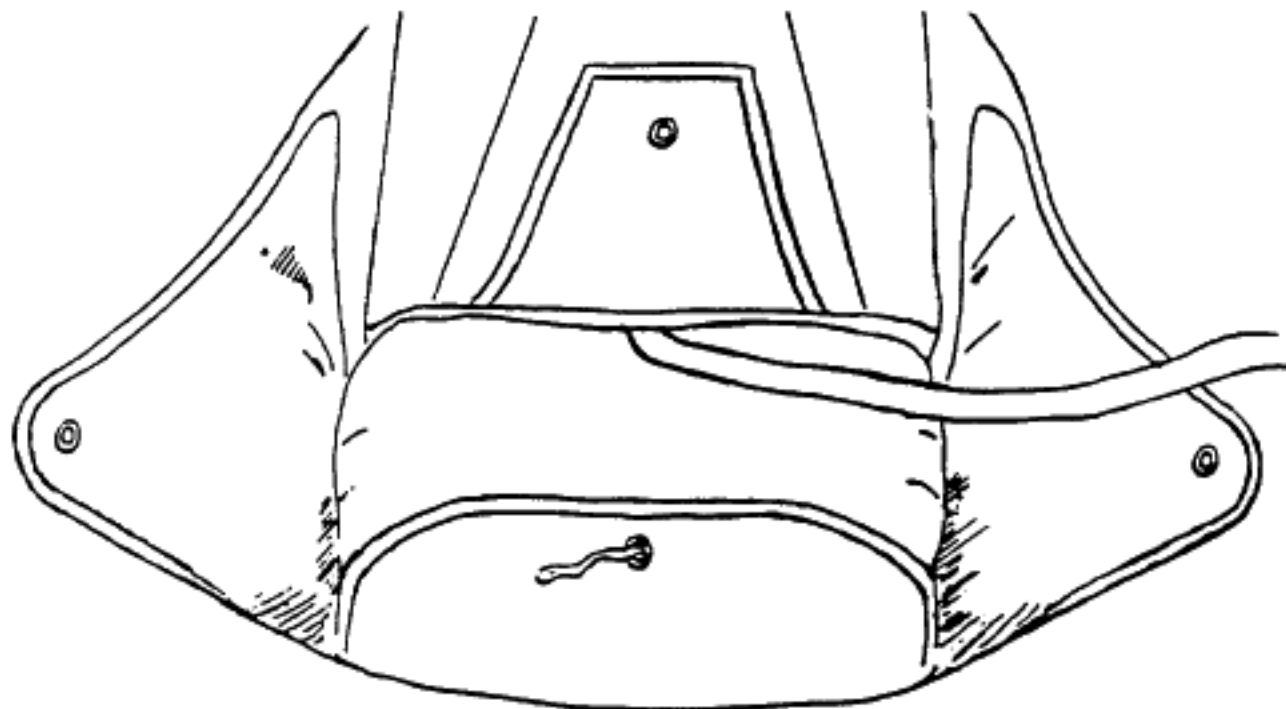

8. Thread a pull-up cord into the locking loop in the bottom flap of the main container. Route it over the main bag and through the grommet on the center flap.

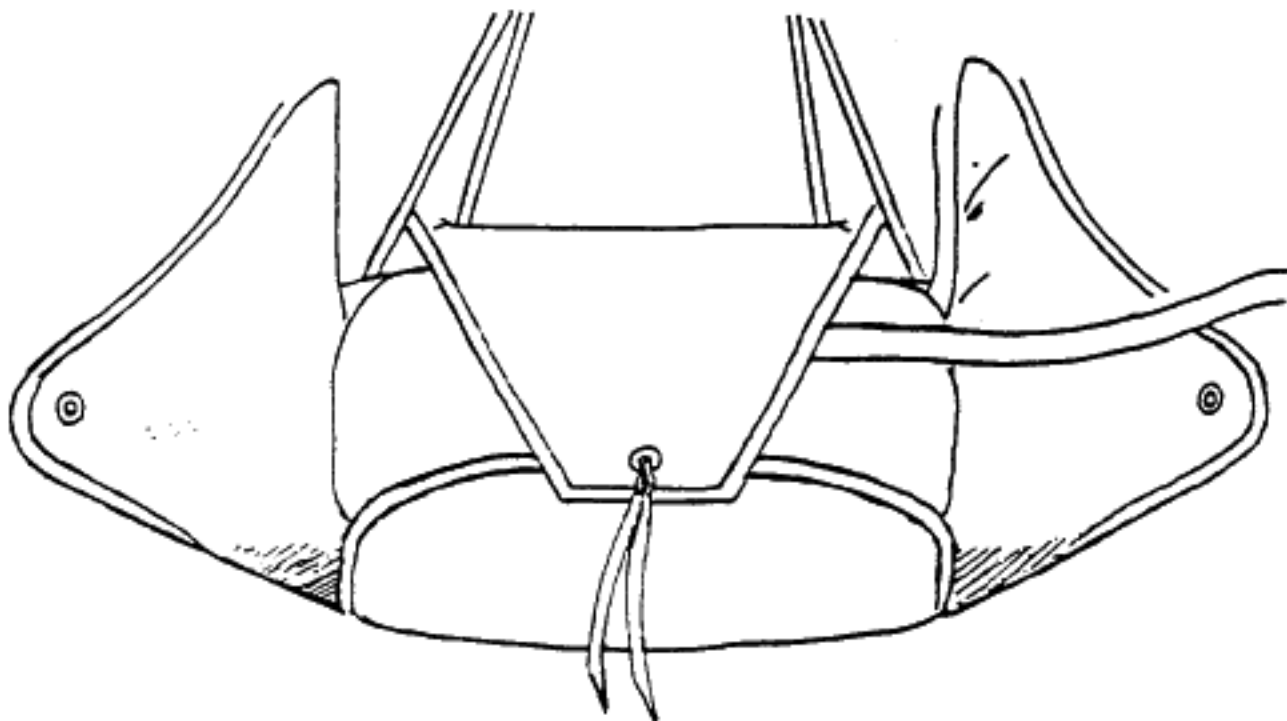
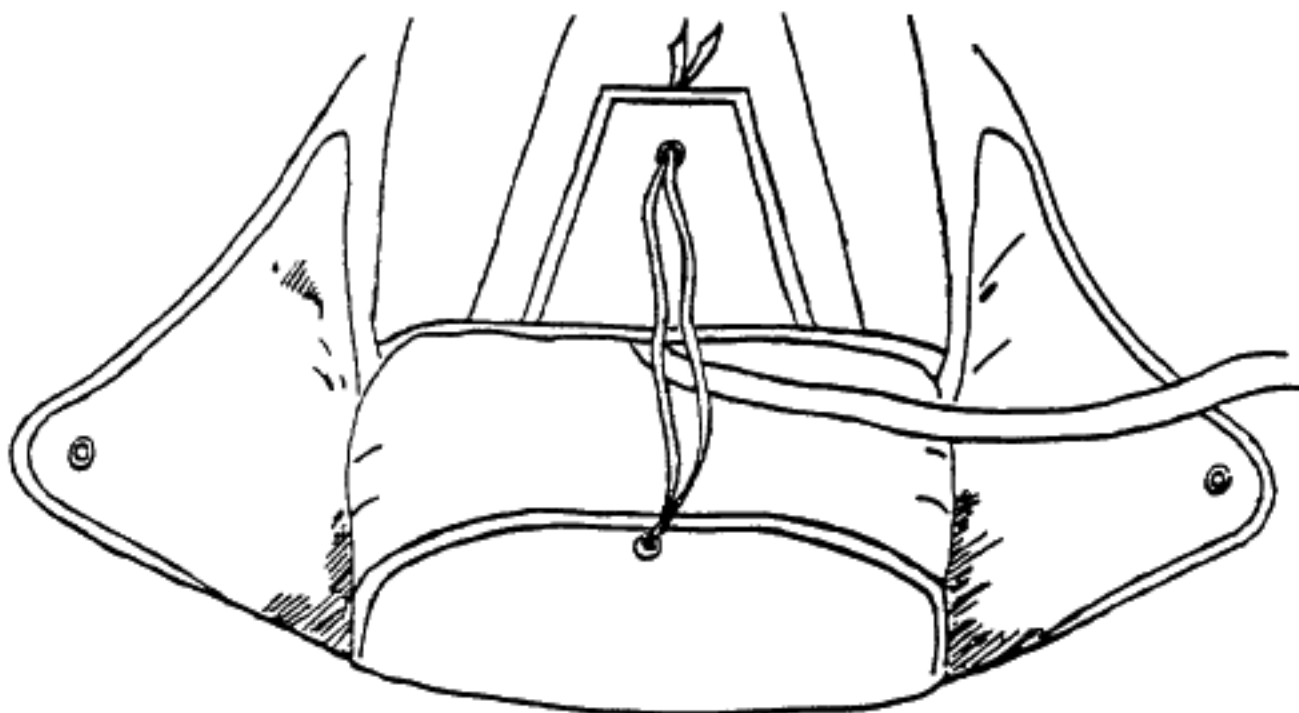

9. After pulling the loop through the center flap grommet, thread it through the right side flap grommet, and pull until the first three grommets are stacked on top of each other.
10. Thread the pull-up cord through the left side flap, pull the closing loop up and insert the pin. (The closing loop is the proper length when the first three grommets are stacked, and the edges of the side flaps just touch, but don't overlap.)

**After pulling the loop through each grommet, pull it tight, smooth the flaps, and then use an extra thumb or knee to hold the looped grommets in place while threading the next grommet. Insert pin after the left side has been pulled tight.**

**The bridle should be placed above the main top flap prior to closing the side flaps allowing about 3-4 inches of bridle to be visible from the pin to where the bridle goes under the right side flap.**

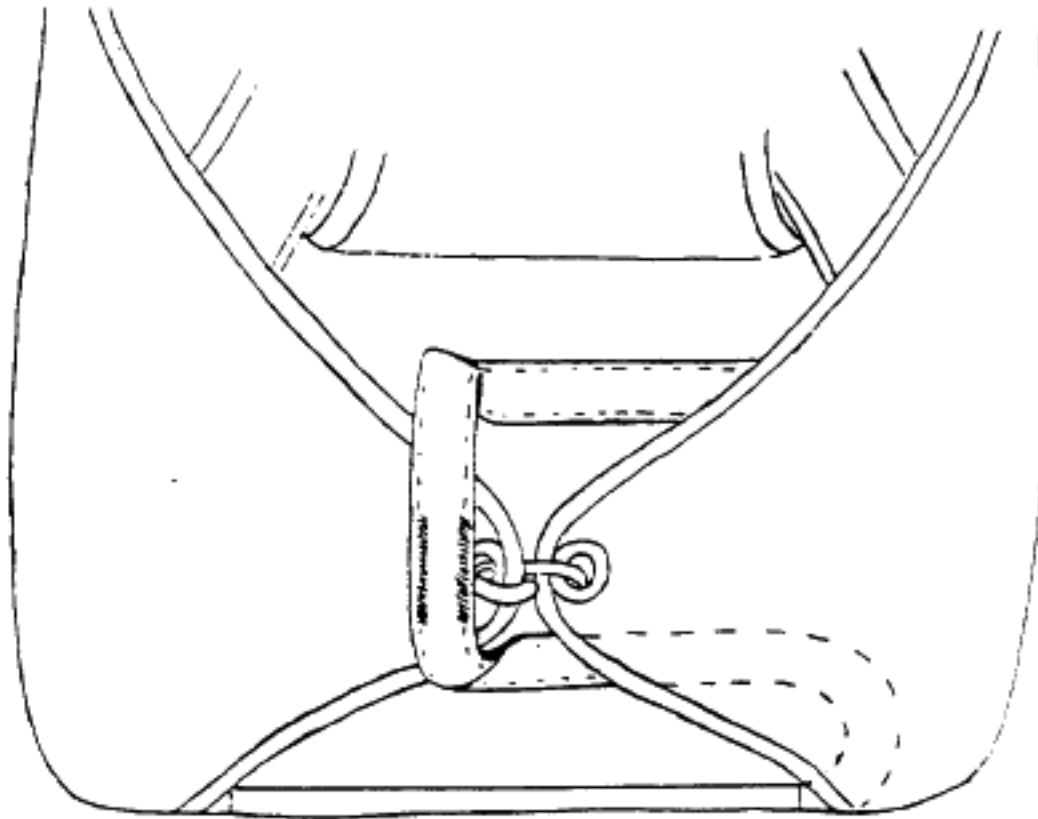

11. (BOC) Fold the pilot chute to best fit into the pocket, and insert it into the pocket. Properly stuff excess bridle under the right main side flap.

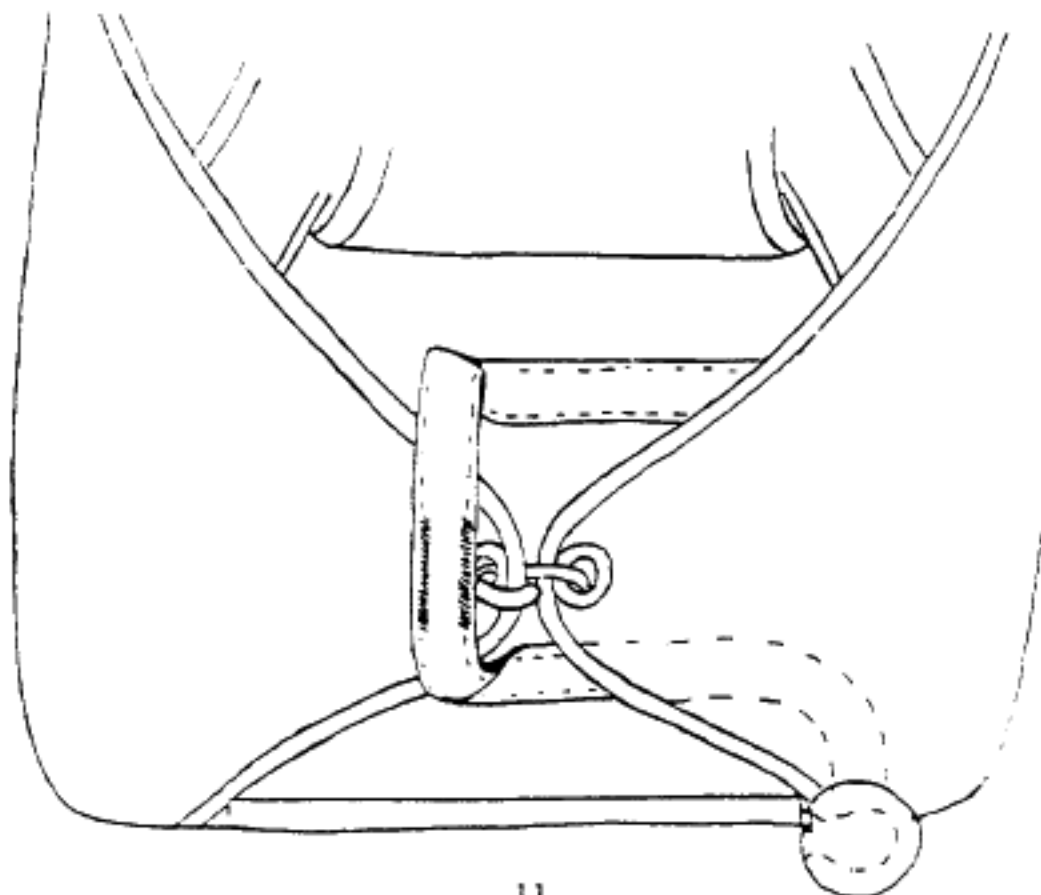

12. Close the cover flap. Dress the corners and the riser covers.

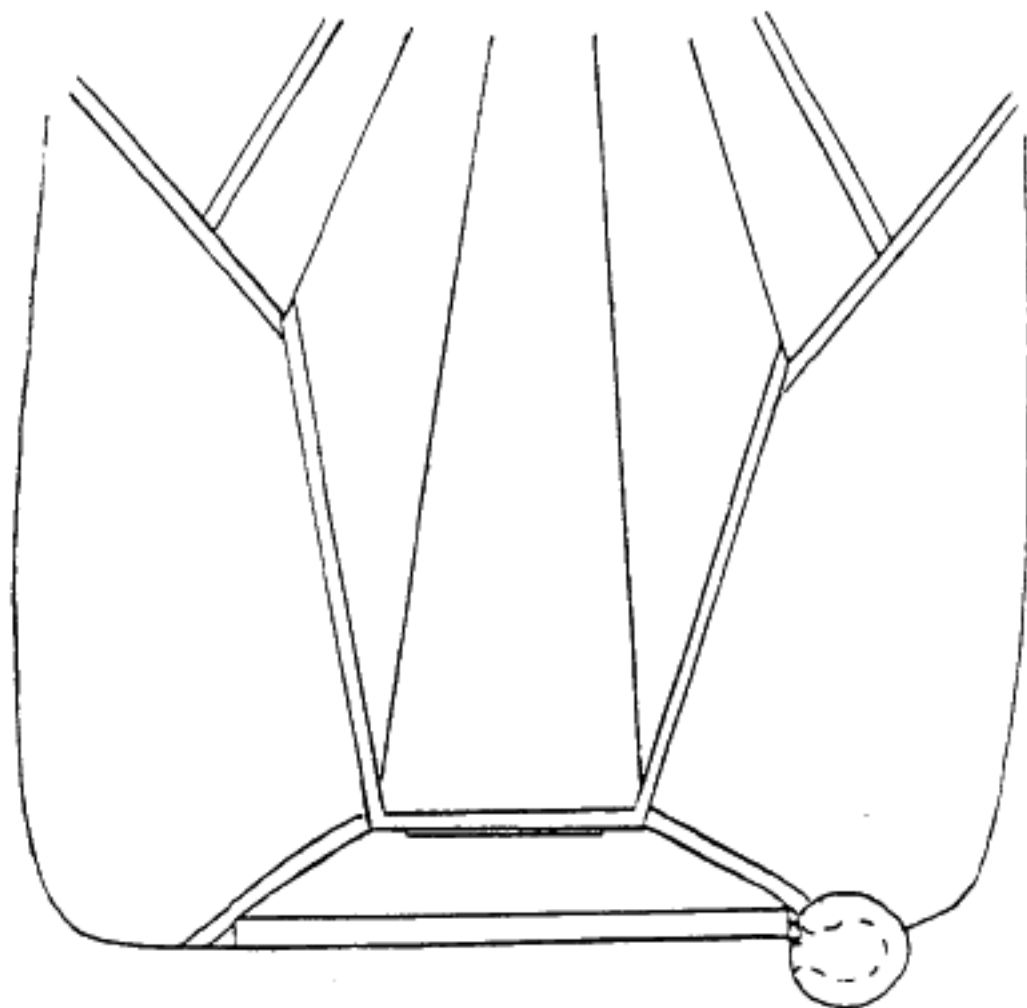

13. (Leg mount)

A. Starting at the pocket end, mate the bridle velcro to the harness/container velcro.

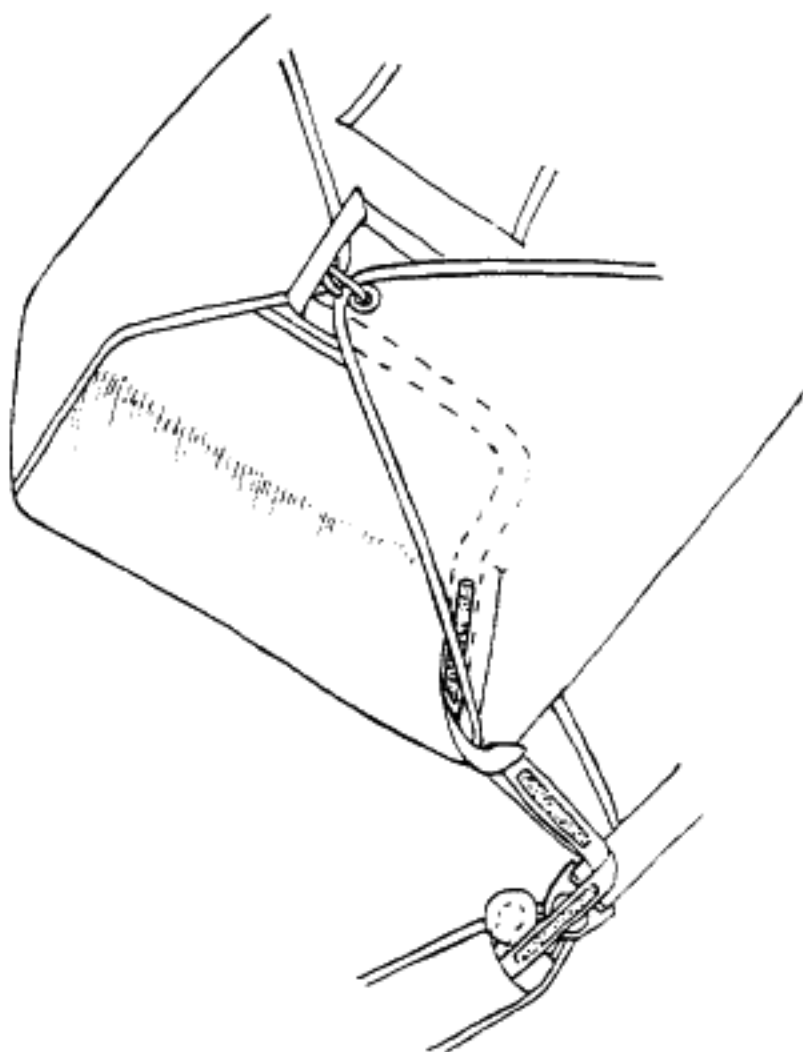

- B. Fold the pilot chute to best fit in the pocket, and insert it into the pocket. Before jumping the first time, test-pull the pilot chute from the pocket (while wearing the rig) to ensure proper installation.

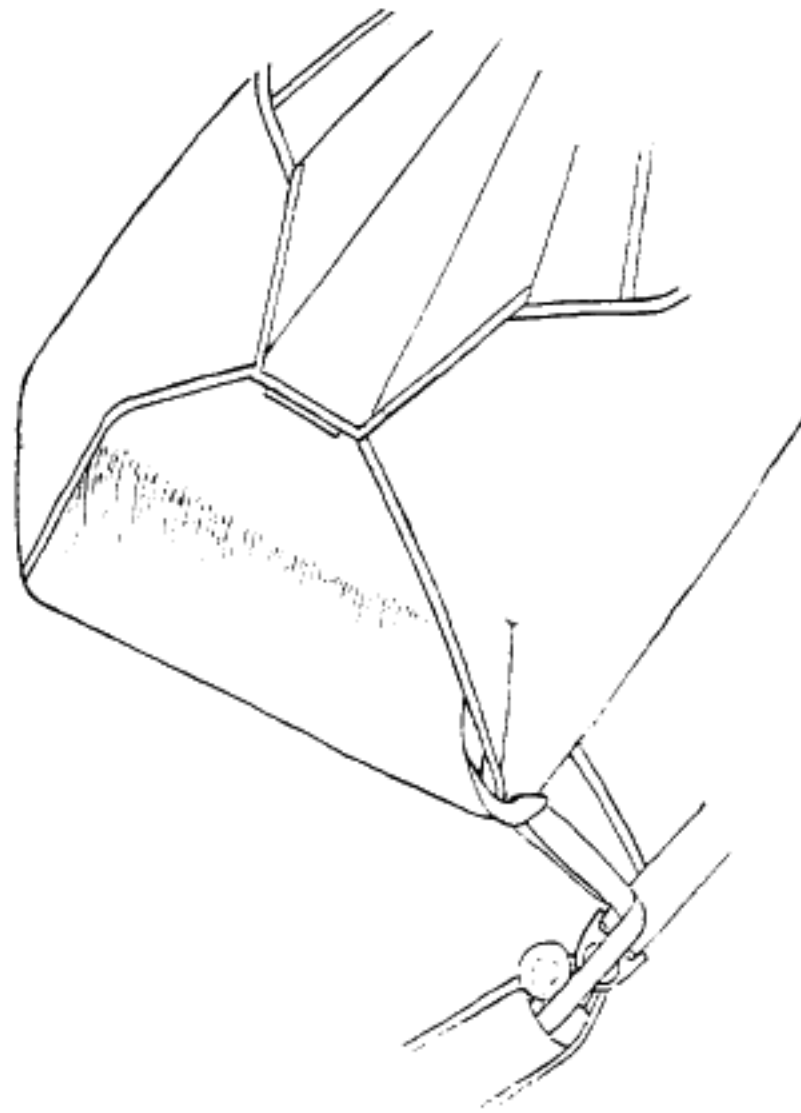

**NOTE: CHECK FOR PROPER ROUTING OF PILOT CHUTE BRIDLE. THE BRIDLE SHOULD GO FROM THE POCKET TO THE PIN, (STOWED UNDER THE SIDE FLAP). ROUTING BETWEEN PIN AND BAG SHOULD GO FROM THE PIN, TO THE RIGHT SIDE OF THE CENTER FLAP, TO THE BAG.**

## FOLDING THE HAND-DEPLOYED MAIN PILOT CHUTE

1. Lay the pilot chute flat with the mesh facing up. Stow the excess bridle from the center of the pilot chute half way to the outside edge.

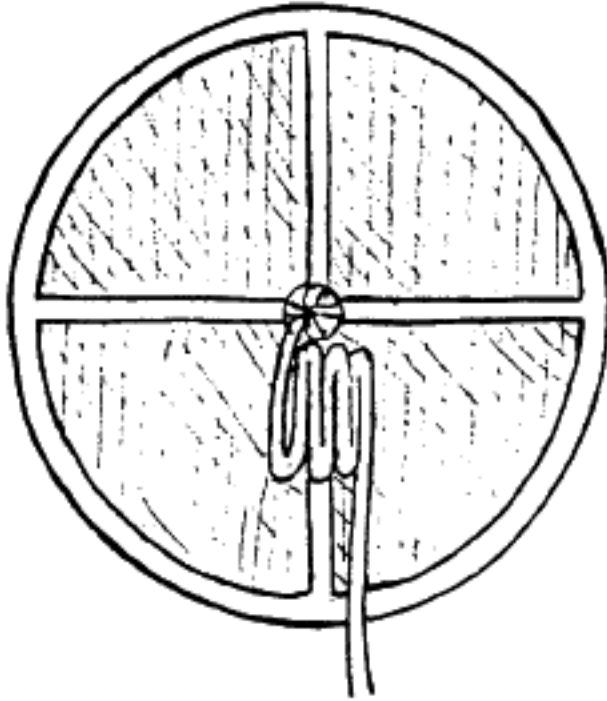

2. Fold the pilot chute in half over the bridle.

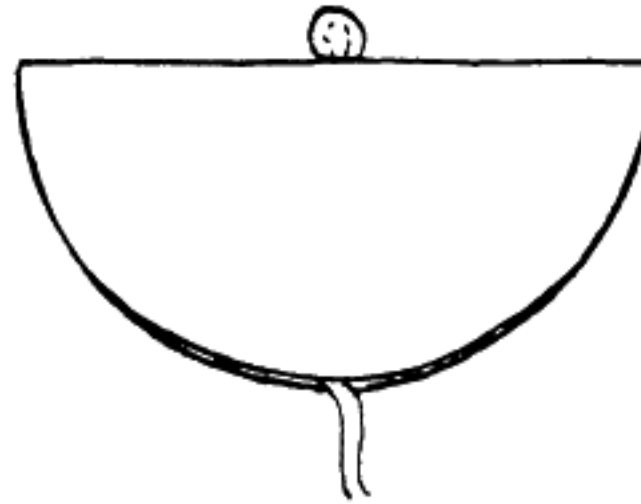

3. Fold the sides in thirds.

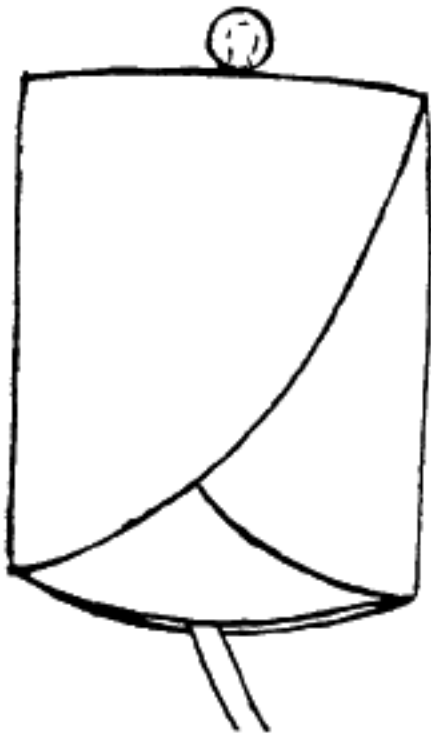

4. Fold the outer edge in half up toward the handle.



5. Fold the pilot chute into thirds.



6. Insert the pilot chute completely into the pocket leaving the handle out. Push the excess bridle into the spandex pocket leaving sufficient slack between the pocket and the pin.

## PULL-OUT PILOT CHUTE

Fold the pilot chute bridle side to side (approximately 6-8 inches long) and lay it across the upper portion of the main bag. Be careful not to allow the bridle to slip between the bag and the reserve container wall. This may inhibit the proper functioning of the pilot chute.

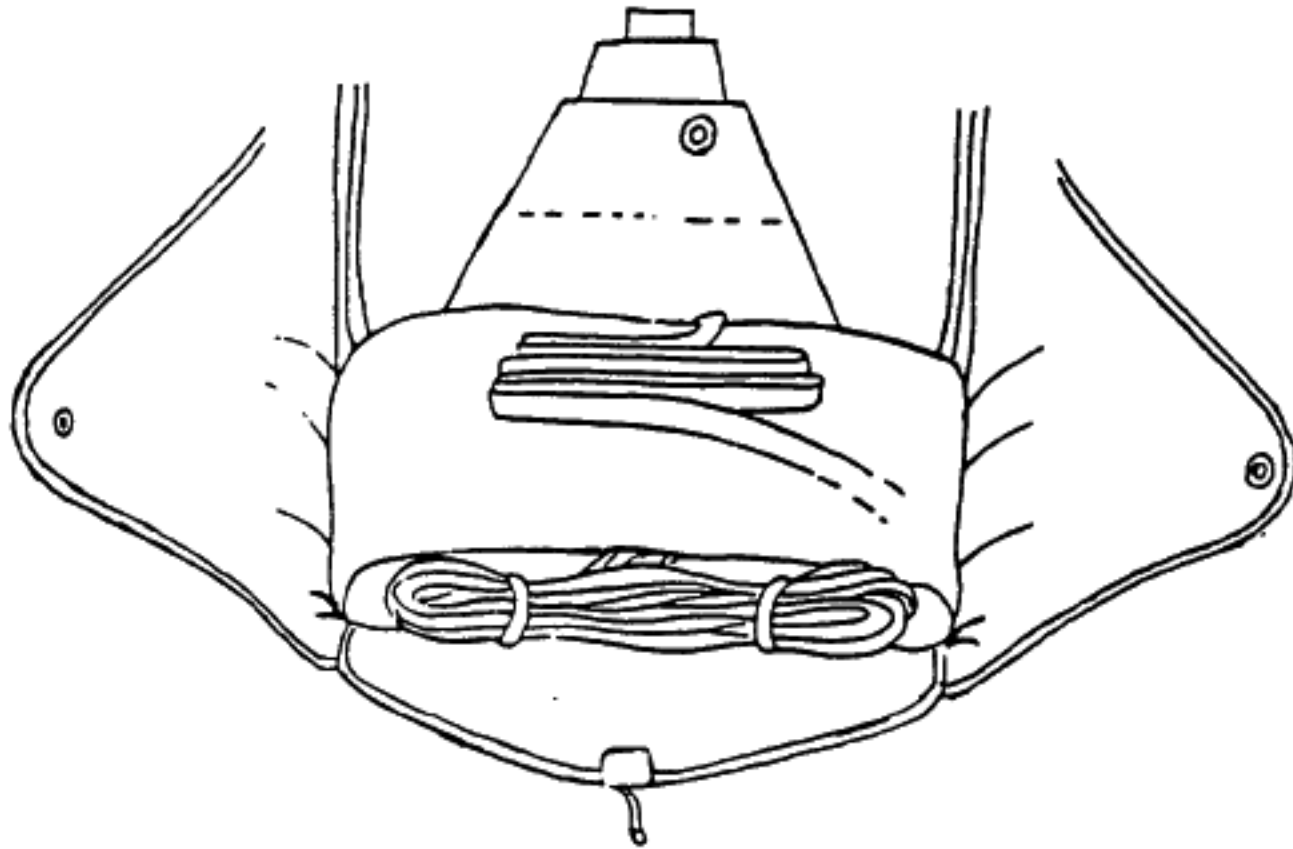

Fold the pilot chute (loosely), and lay it across the bag (as shown). The handle and the pin must exit the container at the lower right side. **IF A KILL-LINE COLLAPSIBLE IS USED, ASSURE THAT IT IS COCKED NOW!**

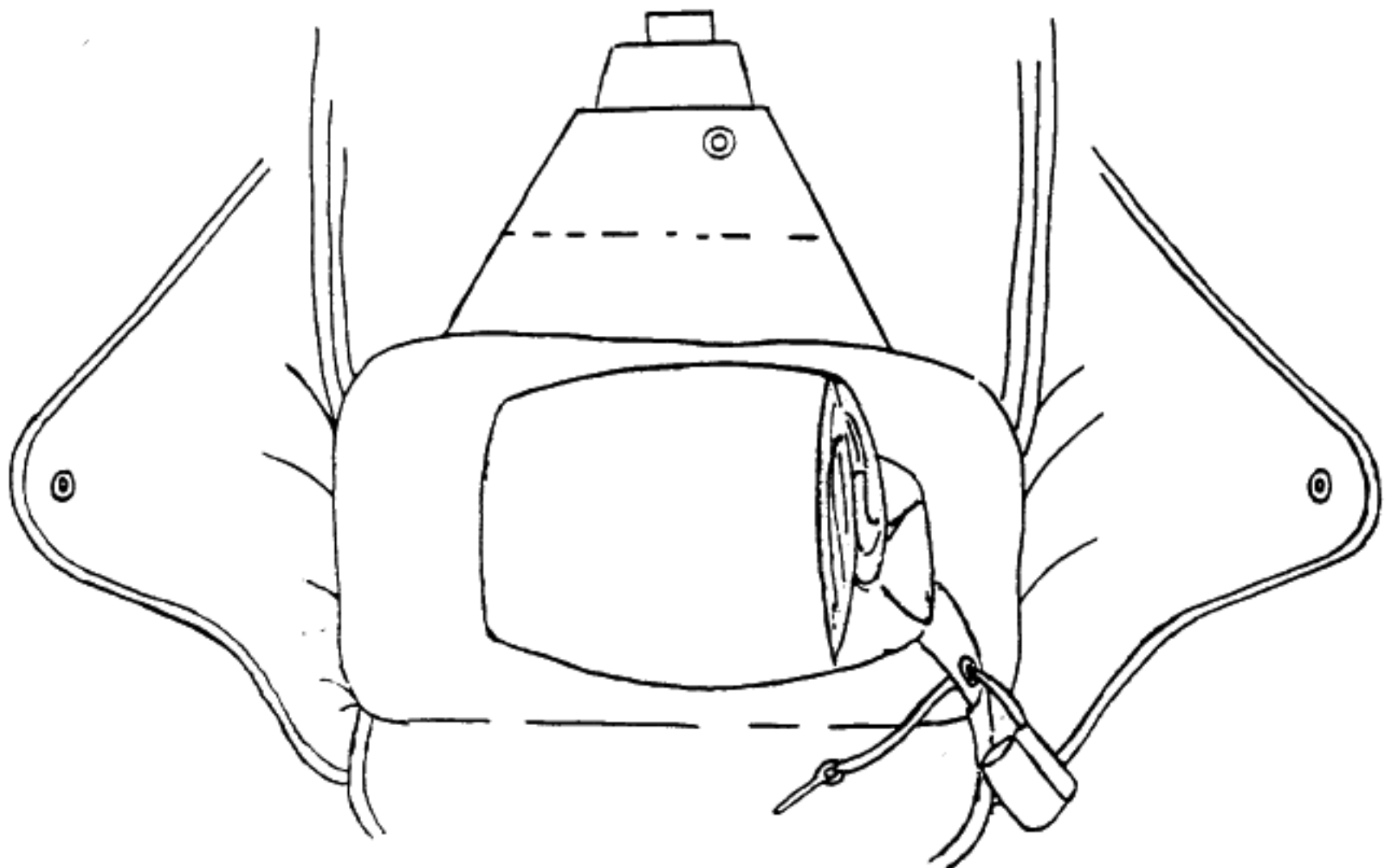



Close the top flap with the handle, and pin outside the main container at the lower right.

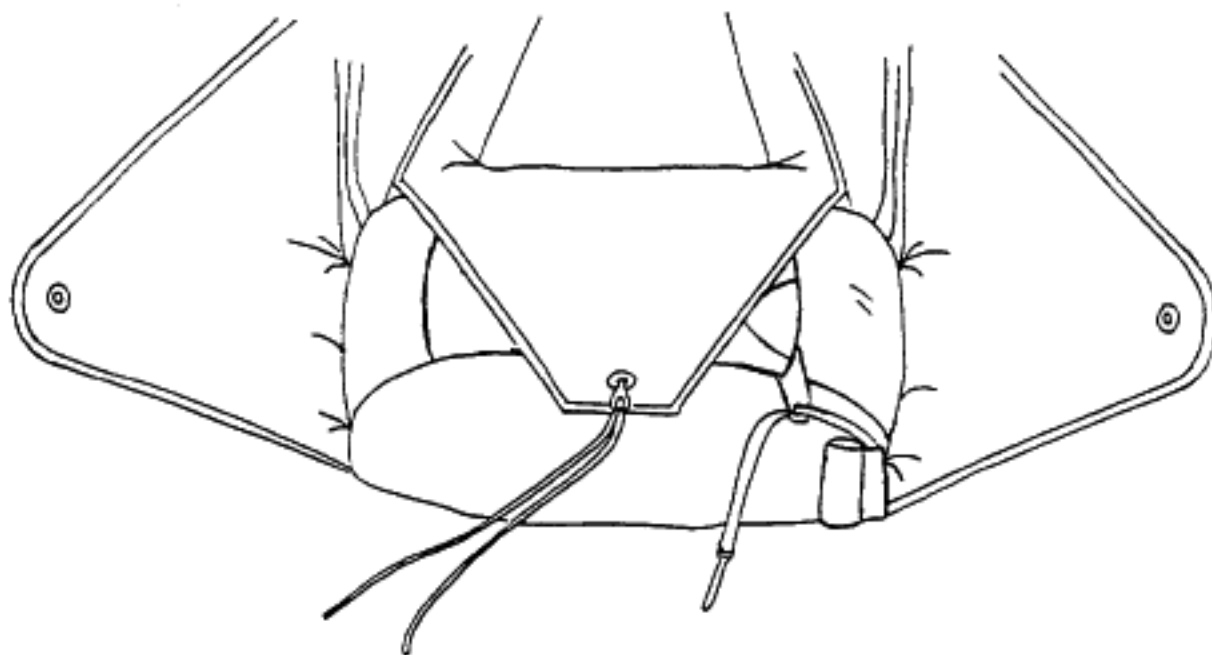

Close the right side flap, then the left side flap, and secure with the pin. Mate the two small tabs of velcro where the handle passes through the grommet.

Tuck the excess bridle under the right side flap, and attach the velcro on the handle to the velcro under the flap on the lower right side of the container.

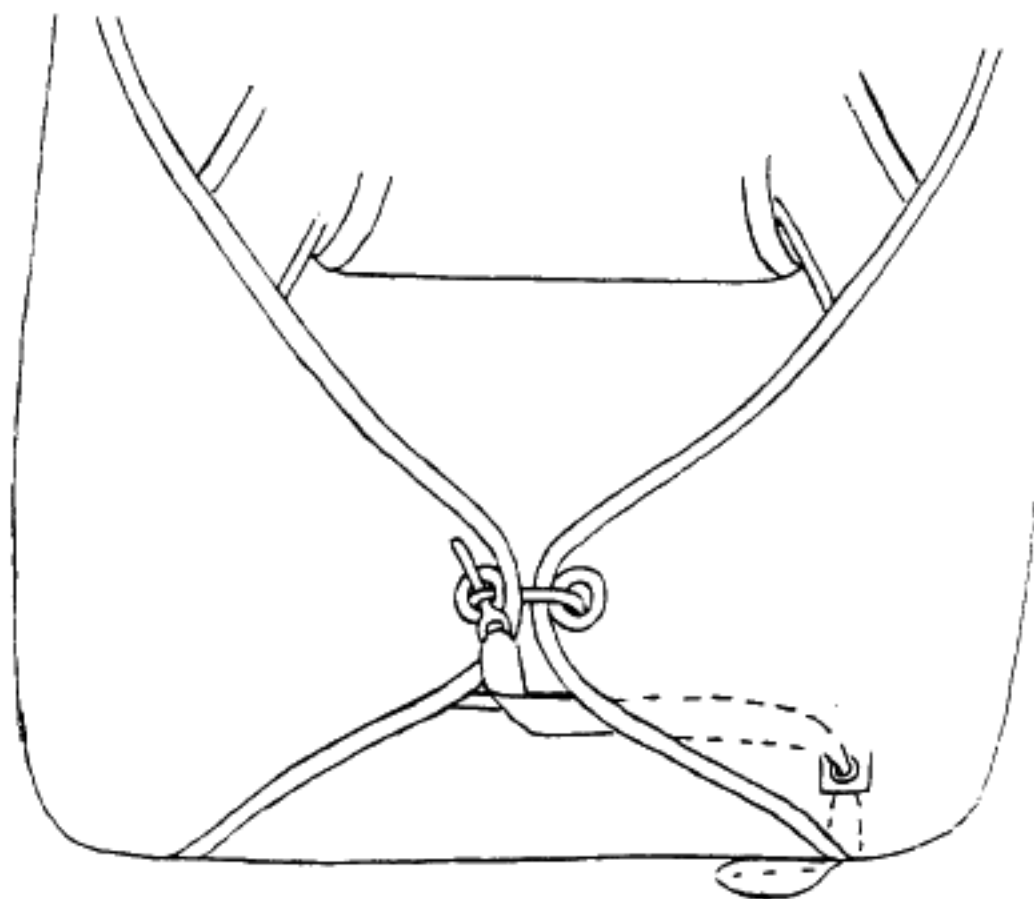

Close the outer main flap and secure with the tuck tab.

## ASSEMBLING THE RESERVE CONTAINER

This document is to be used as a guide for packing reserve parachutes into the *INFINITY* reserve container.

A certificated FAA senior or master rigger is required to pack any reserve or emergency parachute that will be carried in the United States.

Due to the great variety of parachutes available for use as reserves, no instructions for inspection or assembly are contained in this document. THE RIGGER MUST FOLLOW THE CANOPY MANUFACTURER'S INSTRUCTIONS FOR THESE STEPS.

Before you start, record the pertinent data from the canopy. (Many reserves have been packed twice in the same day for want of a number and a date).

### PARTS REQUIRED:

1. *INFINITY* harness/container system
2. *INFINITY* OWNER'S MANUAL
3. Compatible volume reserve canopy (See chart)
4. *INFINITY* reserve pilot chute (Provided)
5. Reserve bridle or free-bag (for square) (Provided)
6. Canopy packing instructions
7. Rubber bands (Round reserve only)
8. Reserve closing loop (Provided)
9. Reserve ripcord (Provided)
10. Lead seal and thread
11. Packing data card (Provided)

### TOOLS REQUIRED: (Round or Square)

1. Large blade screwdriver or 6" adjustable wrench
2. Shot bags, line separator, etc.
3. One (1) pull-up cord 72" long
4. Two (2) 6 x 1 inch strips of pile velcro
5. One (1) temporary pin
6. Seal press / seals / sealing thread
7. Packing paddle and/or hard toggle
8. Pilot chute threading tool
9. Locking pull-up cord or soft bodkin

### ADDITIONAL TOOLS REQUIRED: (SQUARE ONLY)

1. Molar strap (optional)
2. CYPRES pull-up cord and temp pin (if a CYPRES is installed).

# PACKING INSTRUCTIONS: ROUND RESERVE

## PART I: ASSEMBLY

1. This container system requires a **FULL STOW DIAPER** system on a round reserve.
2. Attach a compatible canopy to the four (4) reserve risers with both the canopy and the container/harness system face down on the table. Use the front set of risers for single link set up.
3. If two (2) "L" links are used, the riser ends must be tacked to eliminate the links from rotating. French links are recommended.
4. Using the bridle provided, tie and tack the reserve pilot chute to the apex of canopy in the accepted fashion. **NOTE:** A 6 ft. length of 1-inch Type IV tape (1-in. square weave) should be used. An **INFINITY RESERVE PILOT CHUTE IS REQUIRED.**

## PART II: PACKING

1. After line continuity has been established, tighten all connector links. Inspect the pilot chute, bridle, apex, canopy, skirt, lines, toggles, and harness/container system for integrity.
2. Tack the steering toggles, if applicable.
3. Flake, fold, and diaper canopy according to canopy manufacturer's instructions.
4. Leave a minimum of excess line between the diaper and the risers (12-15 inches).
5. Be sure the closing loop is in place, and install the pull up cord in the closing loop.
6. Turn the harness/container system 90 degrees clockwise on table. Install the diaper in lower left corner of container.

7. Completely fill the lower right corner of the container with canopy material.

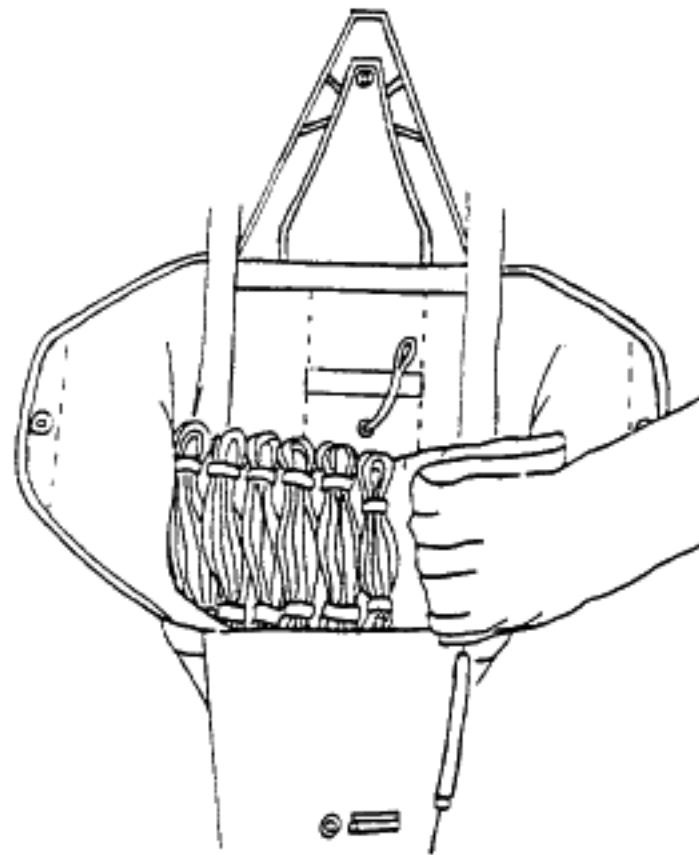

8. Return one fold to the diaper, and place it directly on top of diaper (some types of diapers will require a partial fold to maintain symmetry). Fill the corner again. There will now be three (3) layers of folded canopy material stacked in the lower portion of the container.
- Note:** On some full stow diapered reserves, an extra fold in corner opposite diaper may be required to give a uniform stack of material.

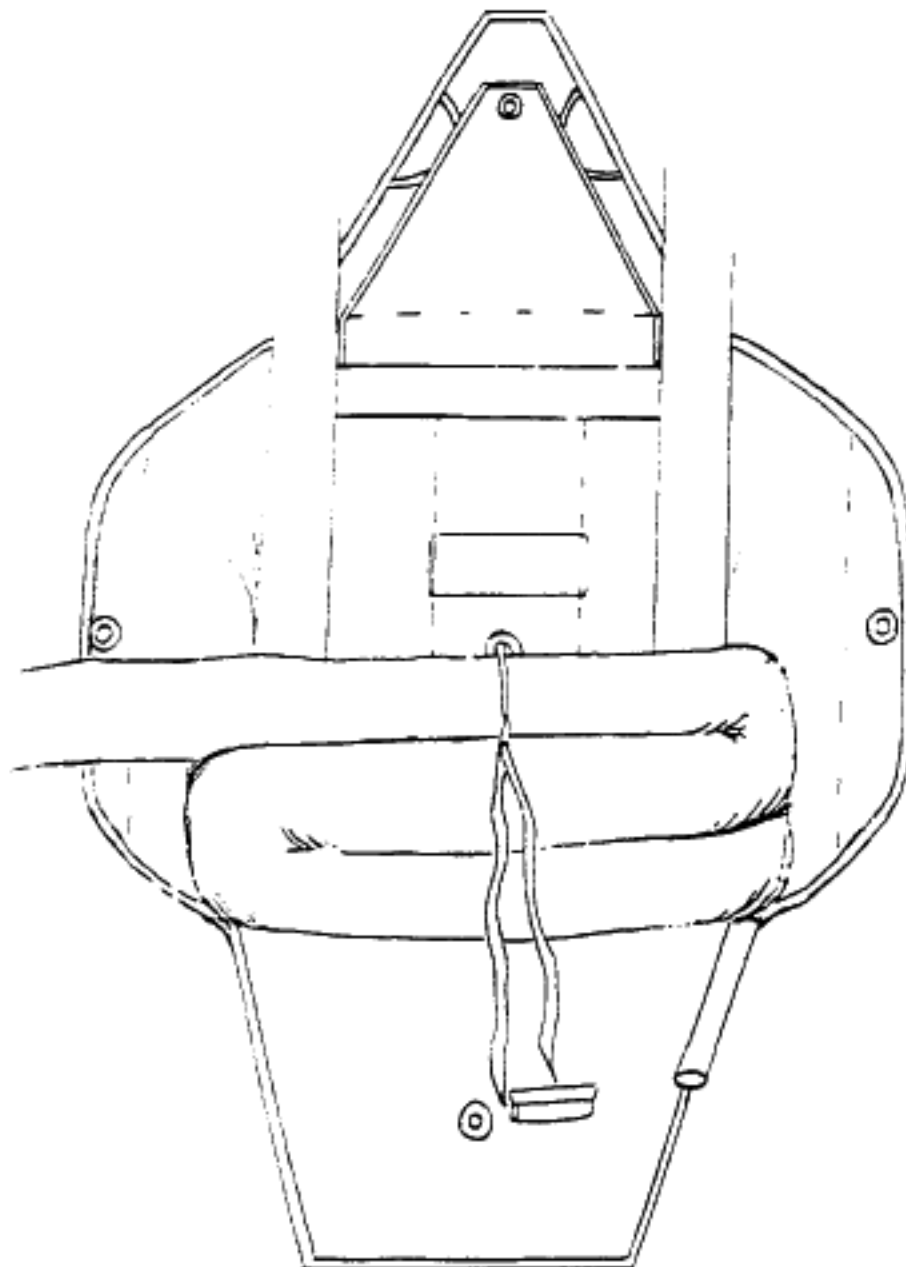

9. "S"-fold the remainder of canopy into container, bottom to top. Pull the pull-up cord through at the most convenient time during this procedure. You want approximately  $\frac{2}{3}$ <sup>rd</sup>s of the bulk below the loop.

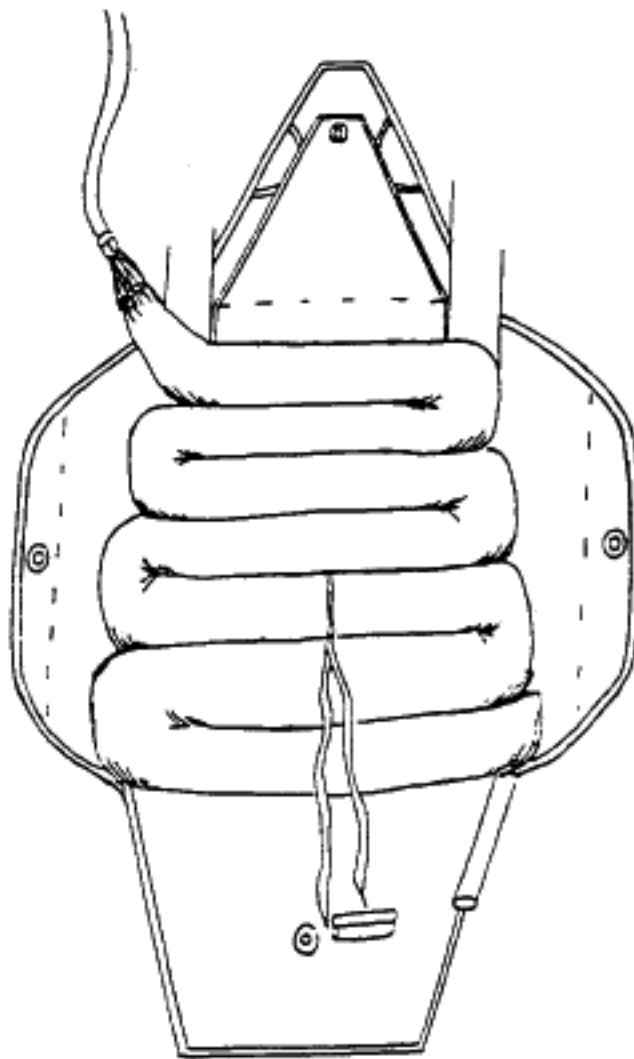

10. Close kicker plate flap (inside bottom). Install the temporary pin. Use a CYPRES pull-up cord if the rig is equipped with a CYPRES.

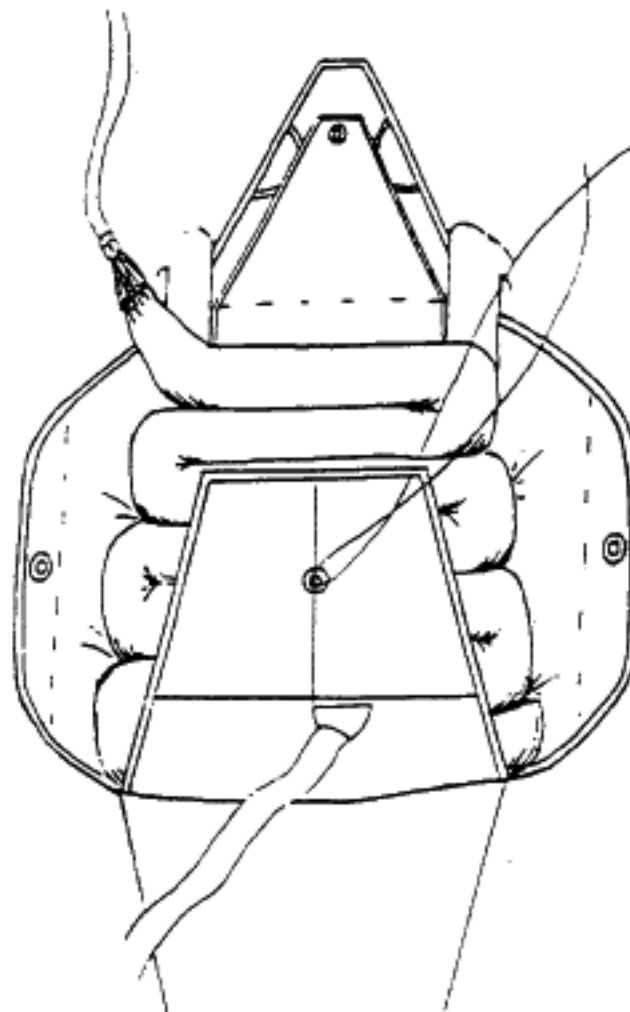

11. Install the bridle in the lower portion of the container on the kicker plate flap (side to side).
12. Thread the 72" pull-up cord through the bottom of reserve pilot chute and then out the top.
13. Collapse the pilot chute by stuffing the excess pilot chute fabric inside the top coils and compressing the spring, so that only the top coil has canopy fabric in it.

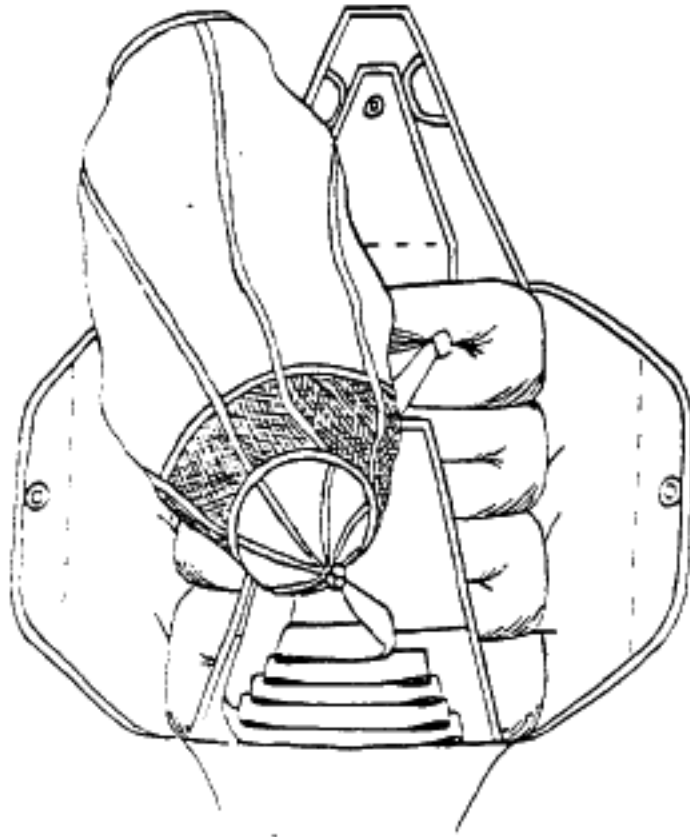

14. Secure the pilot chute with the temporary pin. Then pull the mesh away from the spring and accordian fold it near the cap.

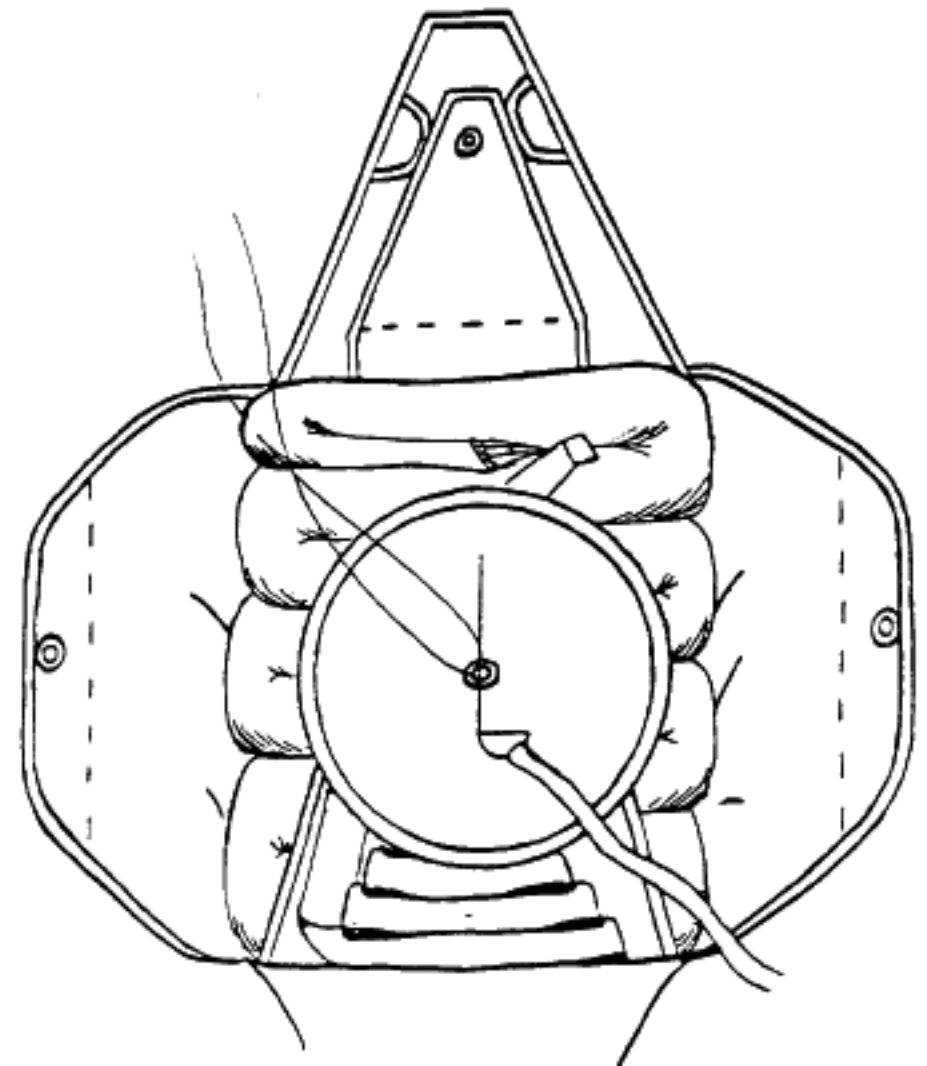
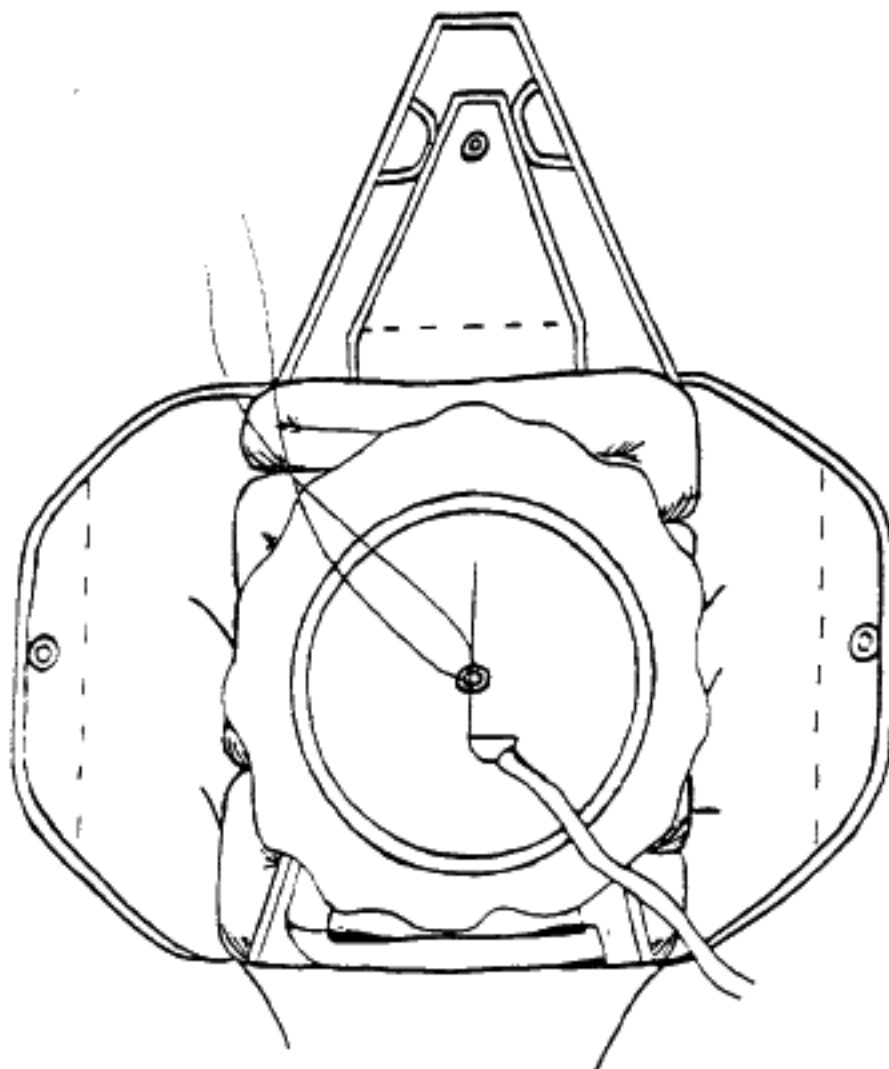

15. Close the side flaps (**RIGHT FLAP FIRST**). Reinstall the temporary pin.

16. Dress the upper corners.

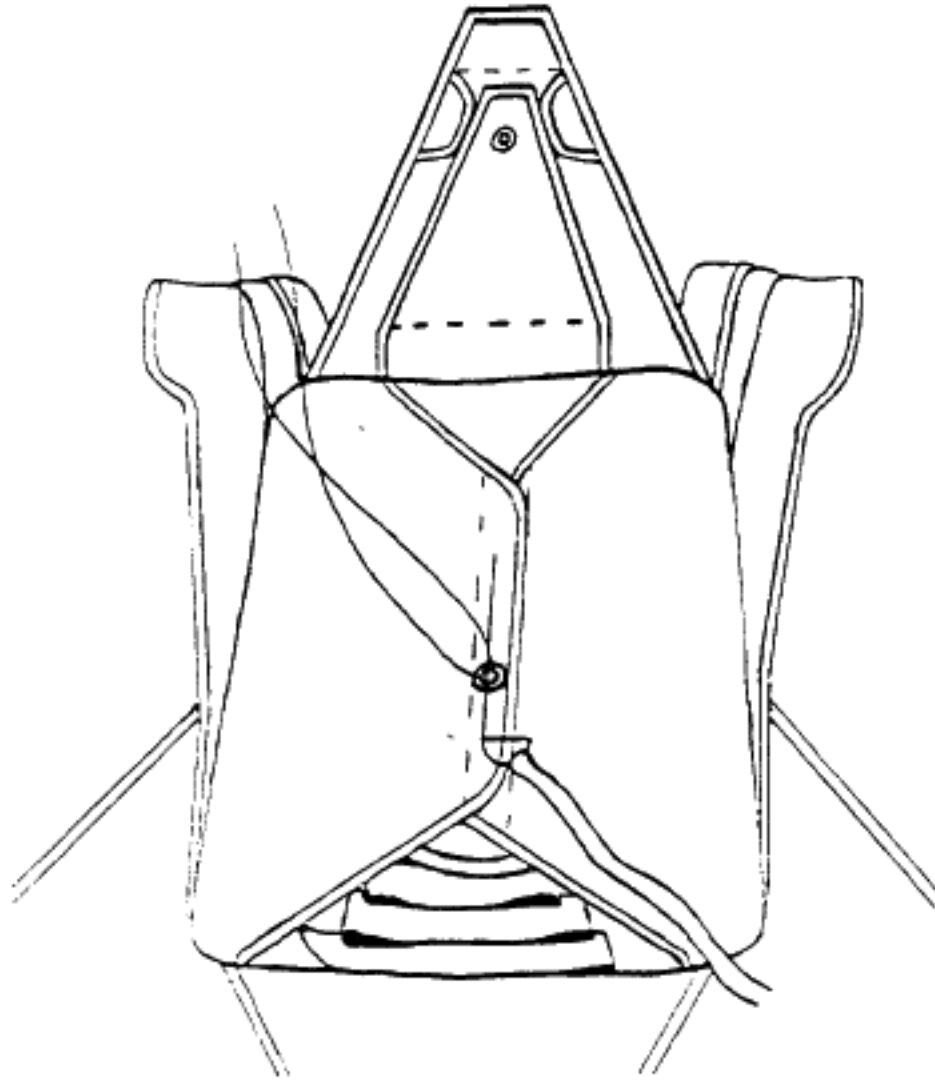

17. Close the inside top flap. Pull up the closing loop and reinstall the temporary pin. **NOTE:**  
**If an RSL is to be used, place the lanyard on the ripcord cable now (As shown).**

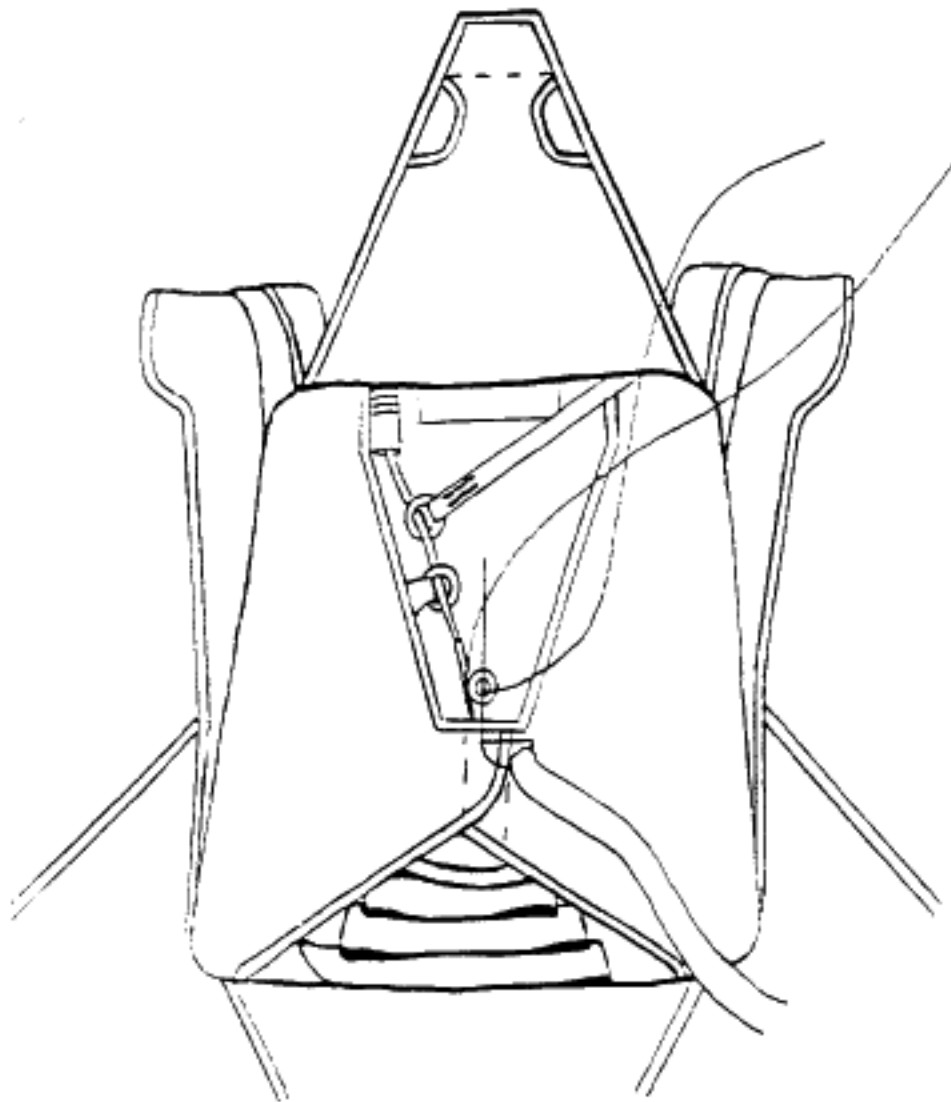

18. Close the bottom flap. Pull up the closing loop and pin with ripcord. **REMOVE THE TEMPORARY PIN**, and insert the ripcord pin. You should not be able to pull up more than  $\frac{1}{4}$  inch of loop.
19. **INSERT THE RIPCORD PIN INTO THE PIN-PROTECTOR POCKET ON THE BOTTOM FLAP.**

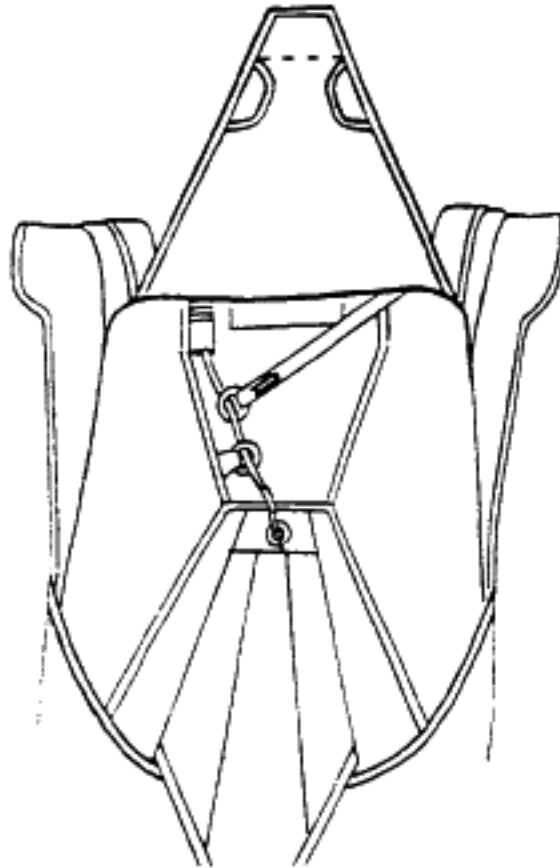

20. Sign the data card (previously filled out) and insert it in the pocket located behind the left ring cover.
21. Verify that the tension on the reserve pin is within specifications and that the appearance is acceptable.
22. Redress the corners if necessary. Install seal in the normal manner, close the top cover flap, and secure it with the tuck-in tabs.
23. **COUNT YOUR TOOLS!!!**

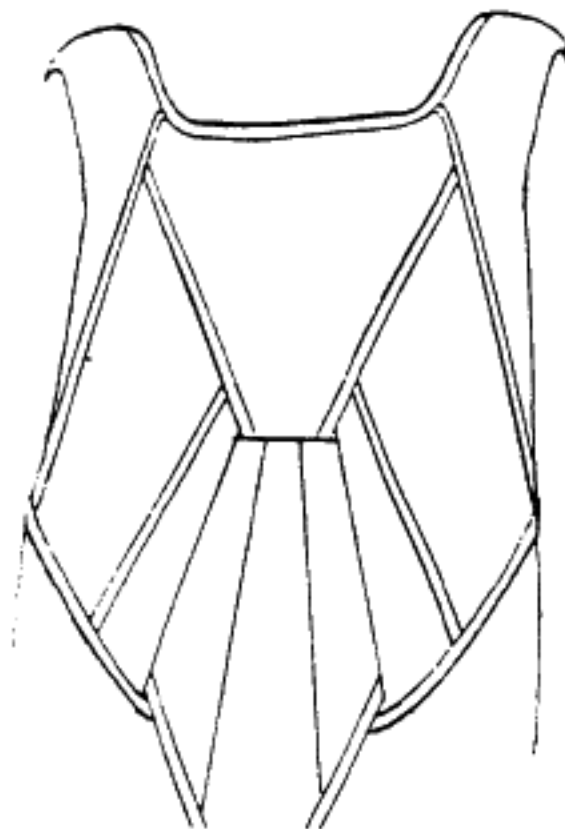



PREPARATION:

BEFORE PROCEEDING, BE SURE THE VOLUME OF THE RAM AIR CANOPY TO BE USED MATCHES THE VOLUME OF THE RESERVE CONTAINER. FILL OUT THE PACKING DATA CARD WITH THE CANOPY SERIAL NUMBER, MANUFACTURER'S NAME, AND THE DATE OF MANUFACTURE. (Access to the loop is under the elastic at the top side of the closing loop plate located in the center of the reserve container.) INSTALL THE 72" PULL-UP CORD IN THE END OF THE CLOSING LOOP.

PART I: FOLDING THE RESERVE CANOPY AND INSTALLING IN FREE BAG

1. Thoroughly inspect the pilot chute, bridle, D-bag, safety stow, canopy, slider, lines, links, toggles, risers, closing loop, and the harness/container system. Prepare the bag with your velcro strips and locking pull-up cord. Put a bite of bridle in one side of the safety stow.
2. Follow the canopy manufacturer's instructions for attaching canopy to risers and steering lines to toggles. (The toggle system may be used with most canopies. Consult the canopy manufacturer's specific instructions for applicability.)
3. **Fold the reserve canopy according to the canopy manufacturer's instructions.** P.R.O. packing the canopy will help distribute the canopy bulk evenly left and right, and will result in a better looking, properly organized pack job. (The cross-section shows the path of the seams in a properly done propack.)

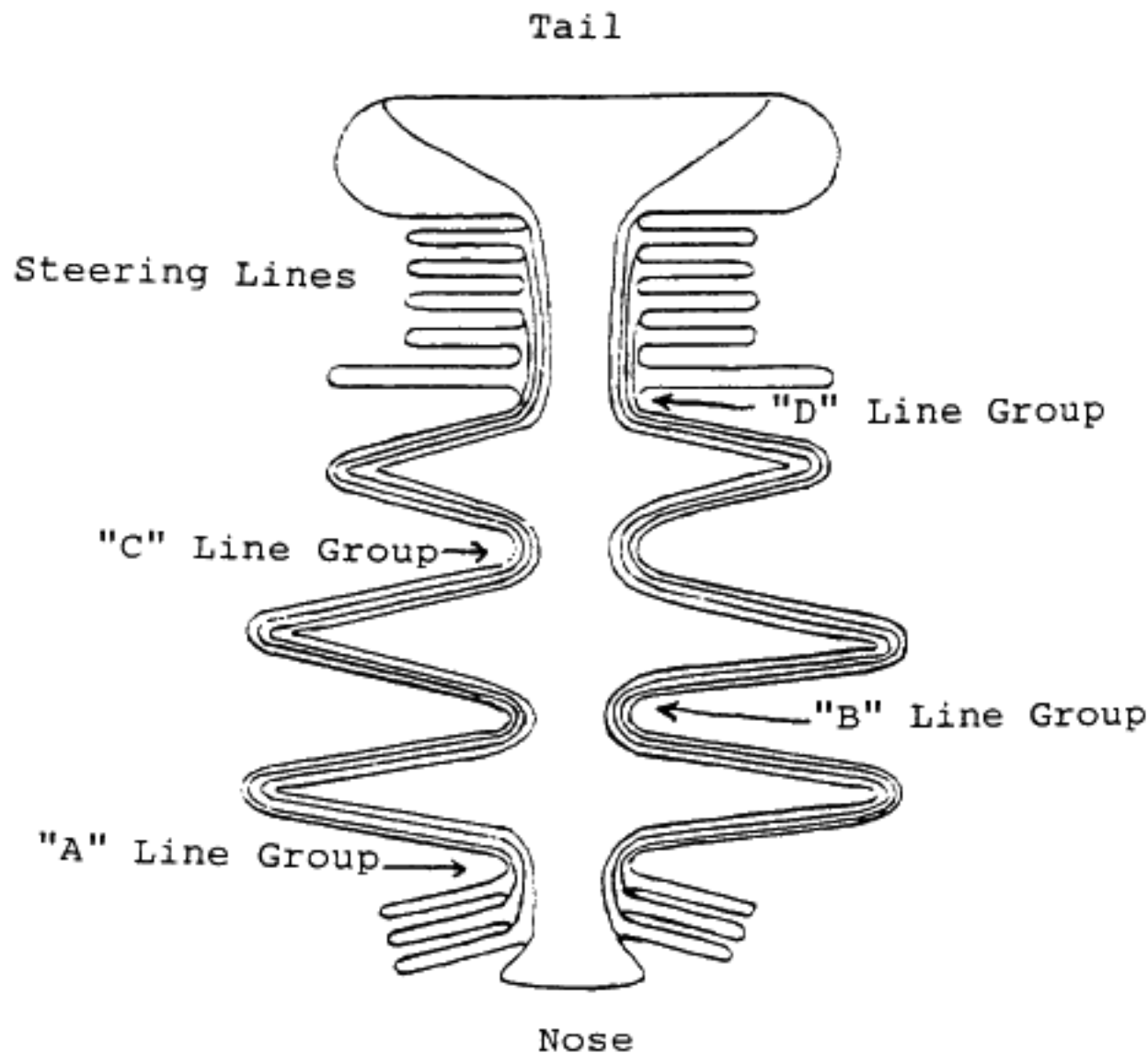

4. Carefully lay the propacked canopy flat on the floor.
5. At this point, the canopy should be much wider than the bag. To make it narrower, fold the fabric between the B-lines and D-lines toward the front of the canopy so that the edge of the fabric is in the fold at the B-lines.
6. Fold the fabric between the A-lines and B-lines toward the tail of the canopy, so that it ends up in the same place as the previous fold.

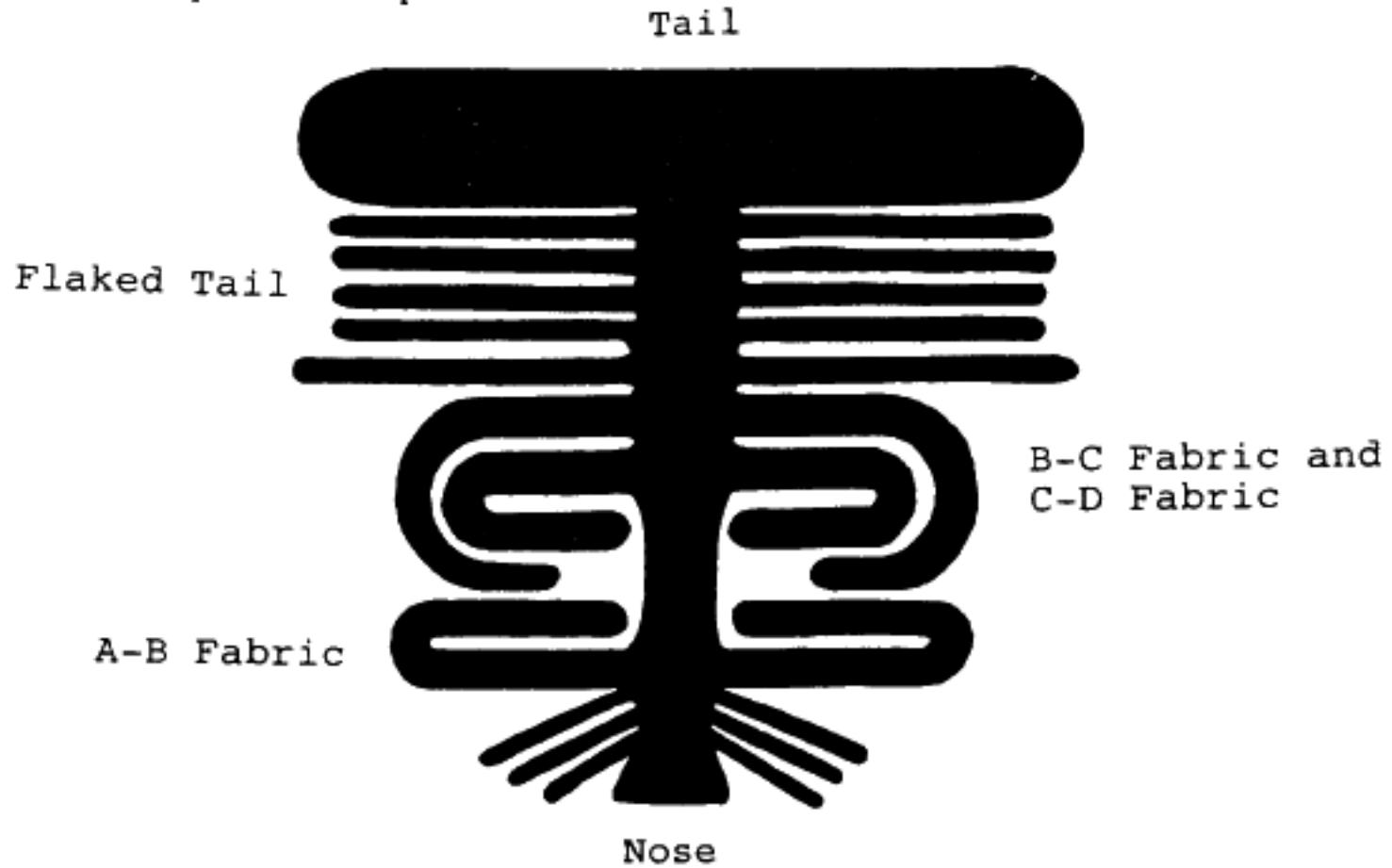

7. At this point, the steering lines should be in the center of the canopy, with the flaked tail hanging past the edge of the canopy. Fold the outside edge of the flaked tail into the crevice between the A-B fabric and the B-D fabric. This method makes the canopy easy to control while folding and keeps the tail well clear of the nose.

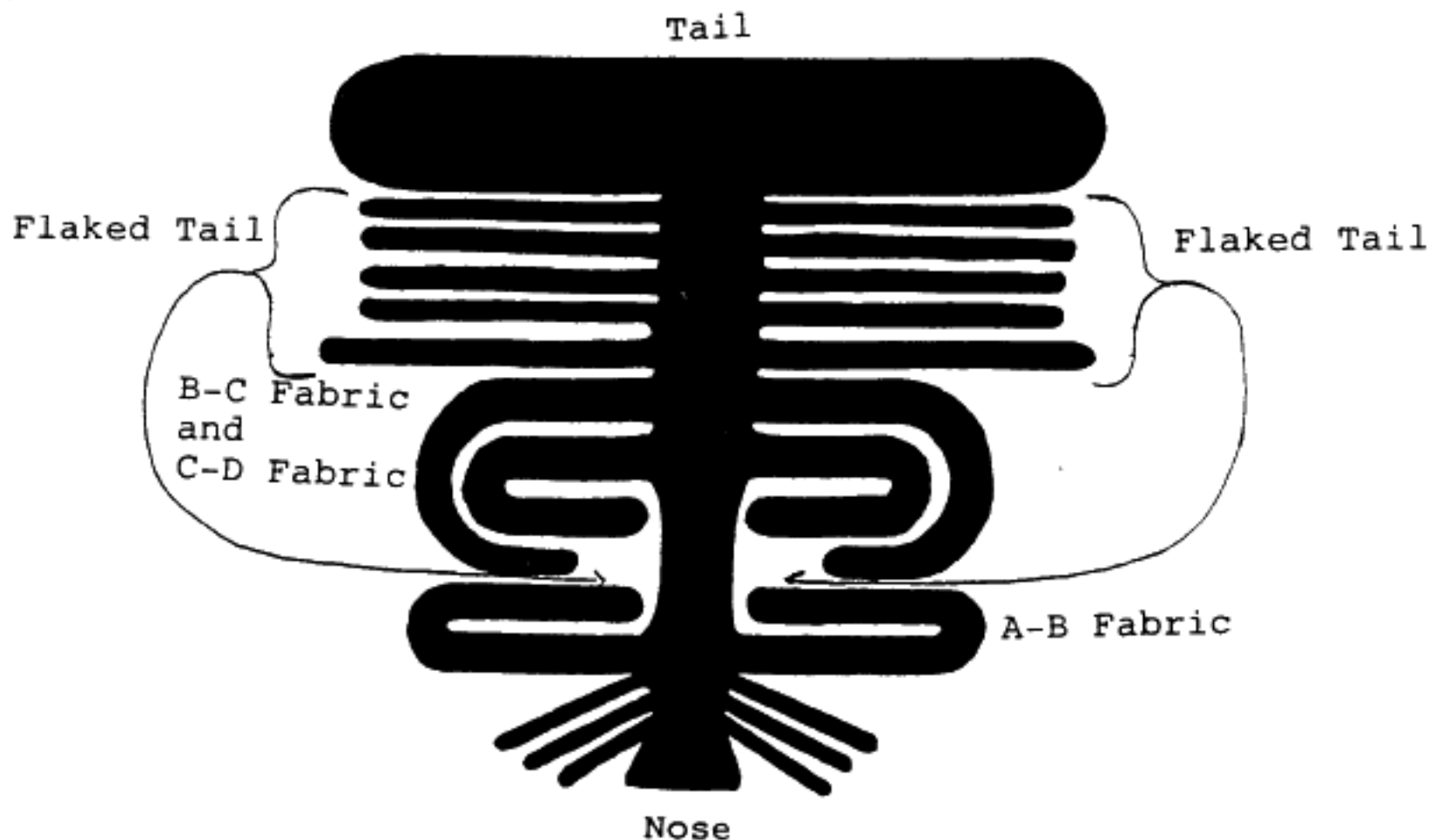

*Once the canopy is folded:*

1. Make a staking fold of the stabilizers and slider so that they are even with the trailing edge of the canopy.



2. Return the center of the tail to its former position (covering the folded stabilizers and slider), and tuck it into our previously formed crevice.
3. Kneeling on top of the first fold, start working the canopy so that it is no more than 2 inches wider than the bag.

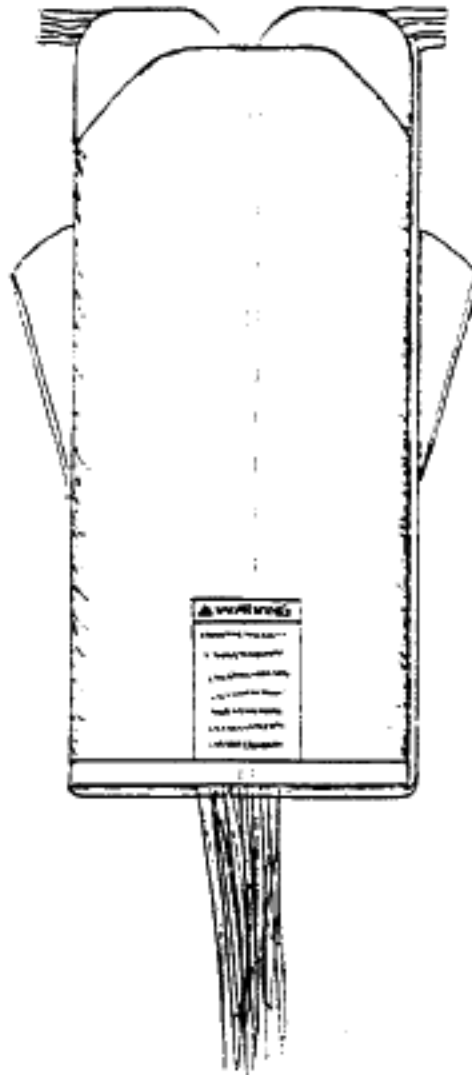

4. After squeezing the air out of the canopy, run your fingers around to the front of the nose, and hook the center cell top skin leading edge tape. Pull it apart until it is straight. Use this to help make the next fold on top of the first.

**NOTE: WE WANT TO HAVE APPROXIMATELY 2/3 OF THE CANOPY BELOW THE GROMMET IN THE BAG.**

5. Kneeling on the second fold and facing the top of the canopy, split the top of the canopy into two sections – much like the shape of a molar tooth. (YOU WILL NOW SEE THE METHOD BEHIND OUR MADNESS. IT IS VERY EASY TO SPLIT THE TOP OF THE CANOPY IF YOU FOLLOW THESE INSTRUCTIONS PROPERLY. Install "MOLAR STRAP" (if used) around the center of the canopy.

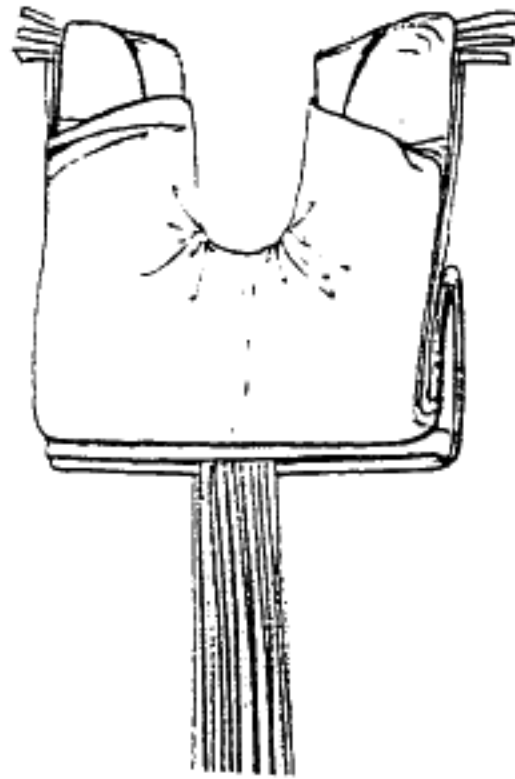

6. Fold the two sections in half neatly and evenly. **THE MOLAR "EARS" SHOULD BE APPROXIMATELY 4-6 INCHES LONG.**

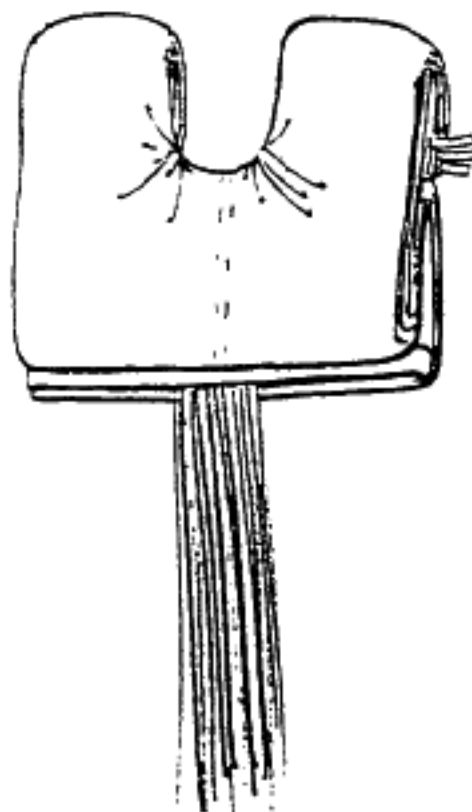

7. Carefully slide the bag over the canopy, placing the "ears" in the bag one at a time. **DO NOT FORCE THE CANOPY TOO FAR INTO THE BAG.**

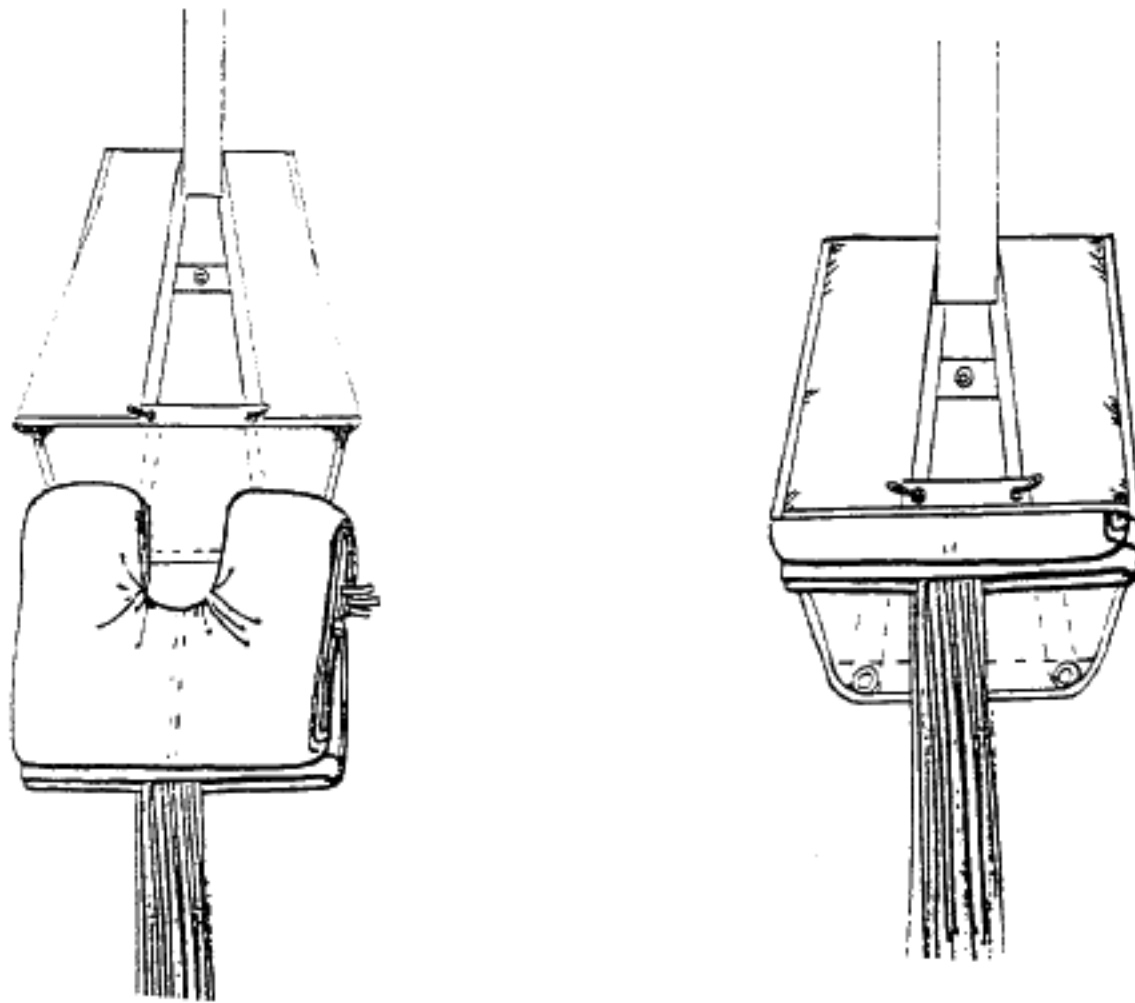

8. REMOVE "MOLAR STRAP" NOW!!! (if used)
9. Close the locking flap with two short bites (2") of the suspension line in the elastic safety stow. Cinch down the locking pull-up cord until the bag resembles a molar bag.

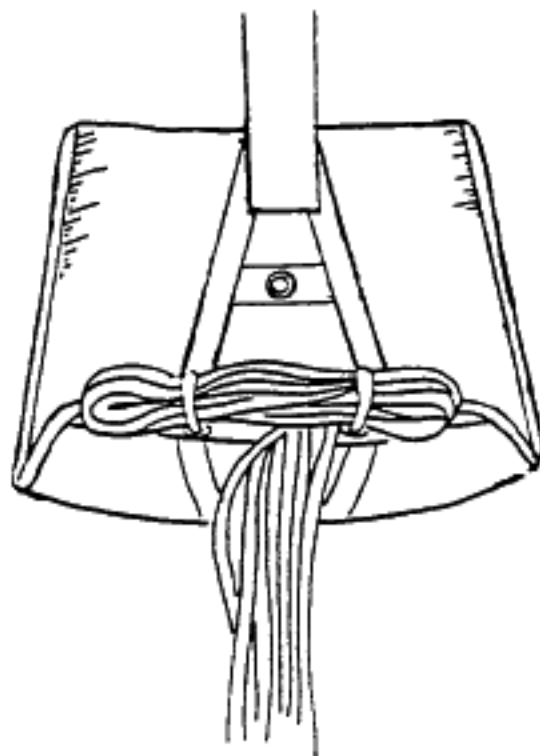

10. Roll up the bottom of the bag until the line stow pocket is facing the container.

11. Open the pocket on the bag and stow the remainder of the suspension lines in the pocket, leaving about 4" of line unstowed. Remove line protectors. Mate the velcro to close the line stow pocket.

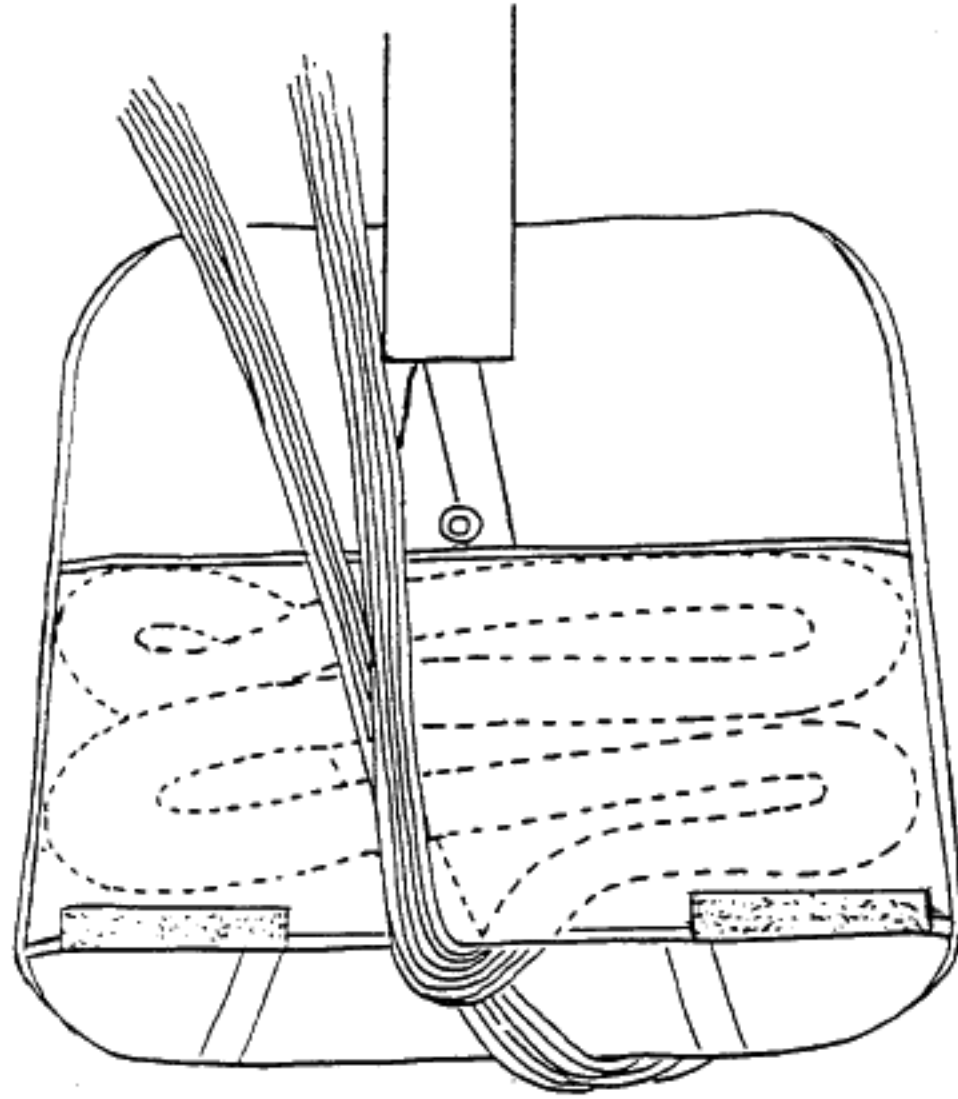

## PART II: INSTALLING INTO CONTAINER AND CLOSING

1. Lay the D-bag into the container with the bridle going out to the top. Now raise the top of the D-bag. Place the risers in the pack tray so that the rear risers are closest to the base of the side flaps and the front risers are closer to the center. Release tension on the locking pull-up cord and feed the ends of the 72" pull-up cord up through it. Pull the closing loop up through the bag and secure with the temporary pin. Completely fill the lower corners of the container. The end of the loop should be approximately  $\frac{1}{2}$  inch below the level of the bag.
2. Feed the pull-up cord through the grommet on the kicker flap. If you are using a **CYPRES**, consult the **CYPRES** section for additional information. Pull the closing loop through the grommet, and secure with the temporary pin. **NOTE: AT THIS TIME MAKE SURE THE CORNERS OF THE RESERVE CONTAINER ARE FULL!**
3. Make two folds of bridle on each side of the kicker flap; the folds should reach the row of stitching just past the grommet in the kicker flap. **Do not make the folds so long that they reach the corners of the container.**

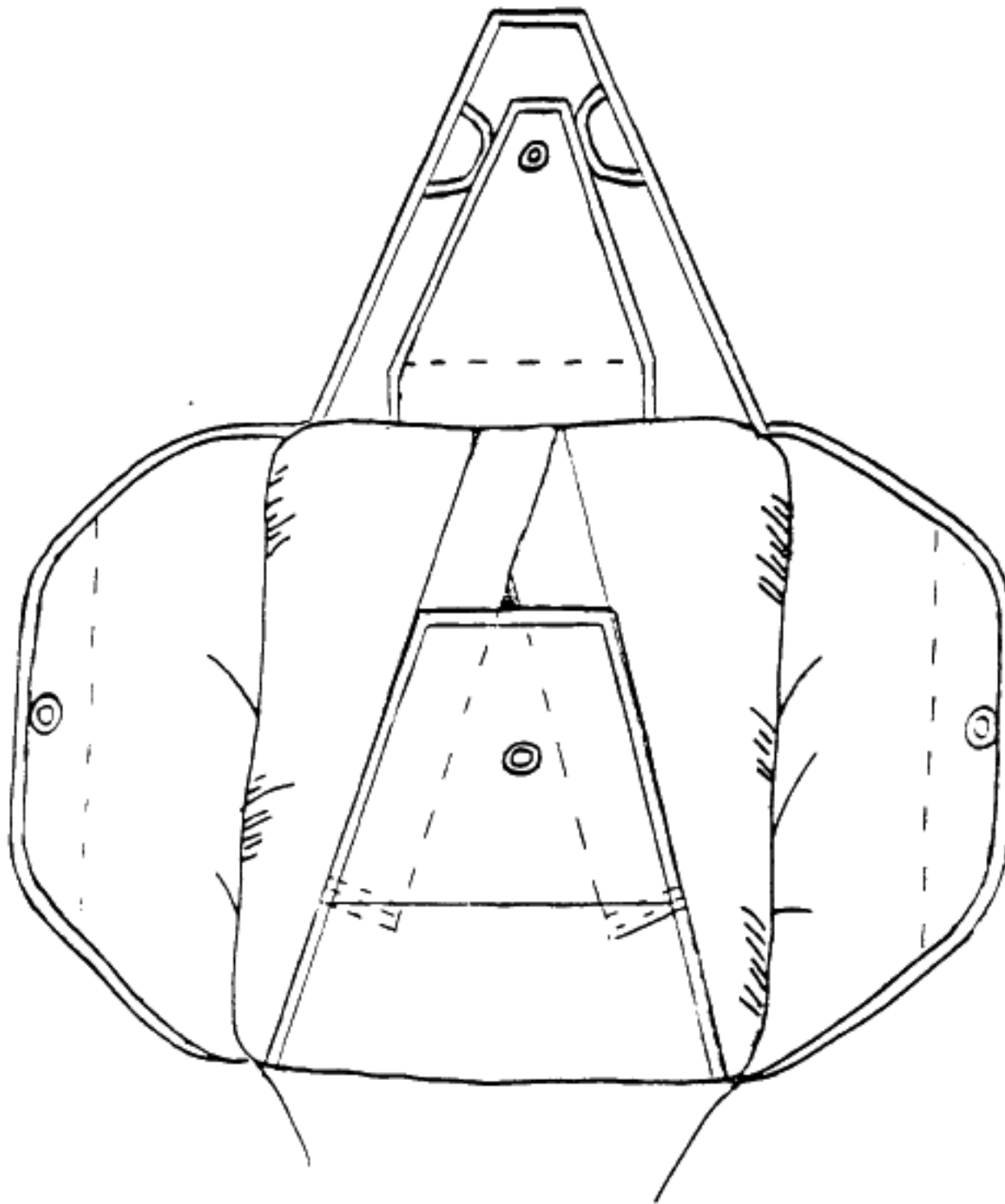

4. Fold the remaining bridle side to side across the base of the kicker flap under the center flap. **Make the folds narrow enough so that they don't get covered by the side flaps.**

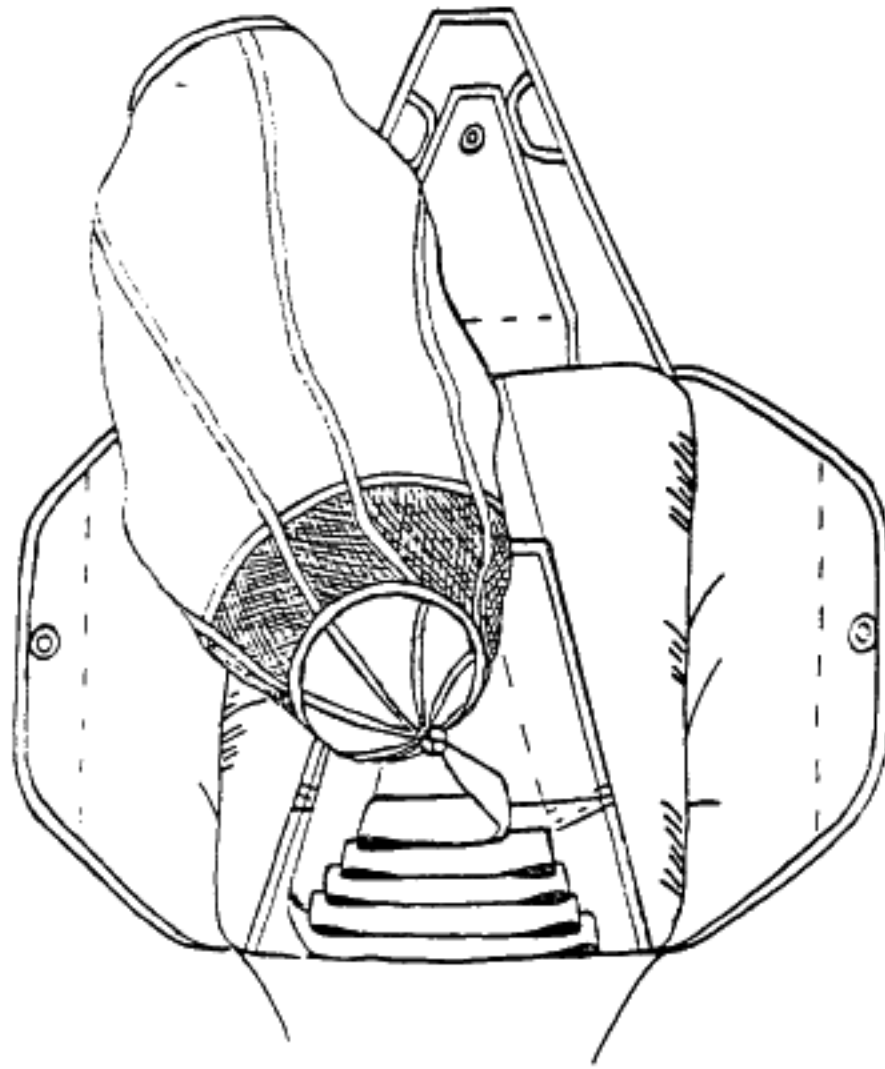

5. Thread the pull-up cord through the bottom of the reserve pilot chute and the out the top.
6. Collapse the pilot chute by stuffing the excess pilot chute fabric inside the top coils and compressing the spring, so that only the top coil has canopy fabric in it.





7. Secure the pilot chute with the temporary pin. Then pull the mesh away from the spring and accoridian fold it near the cap.

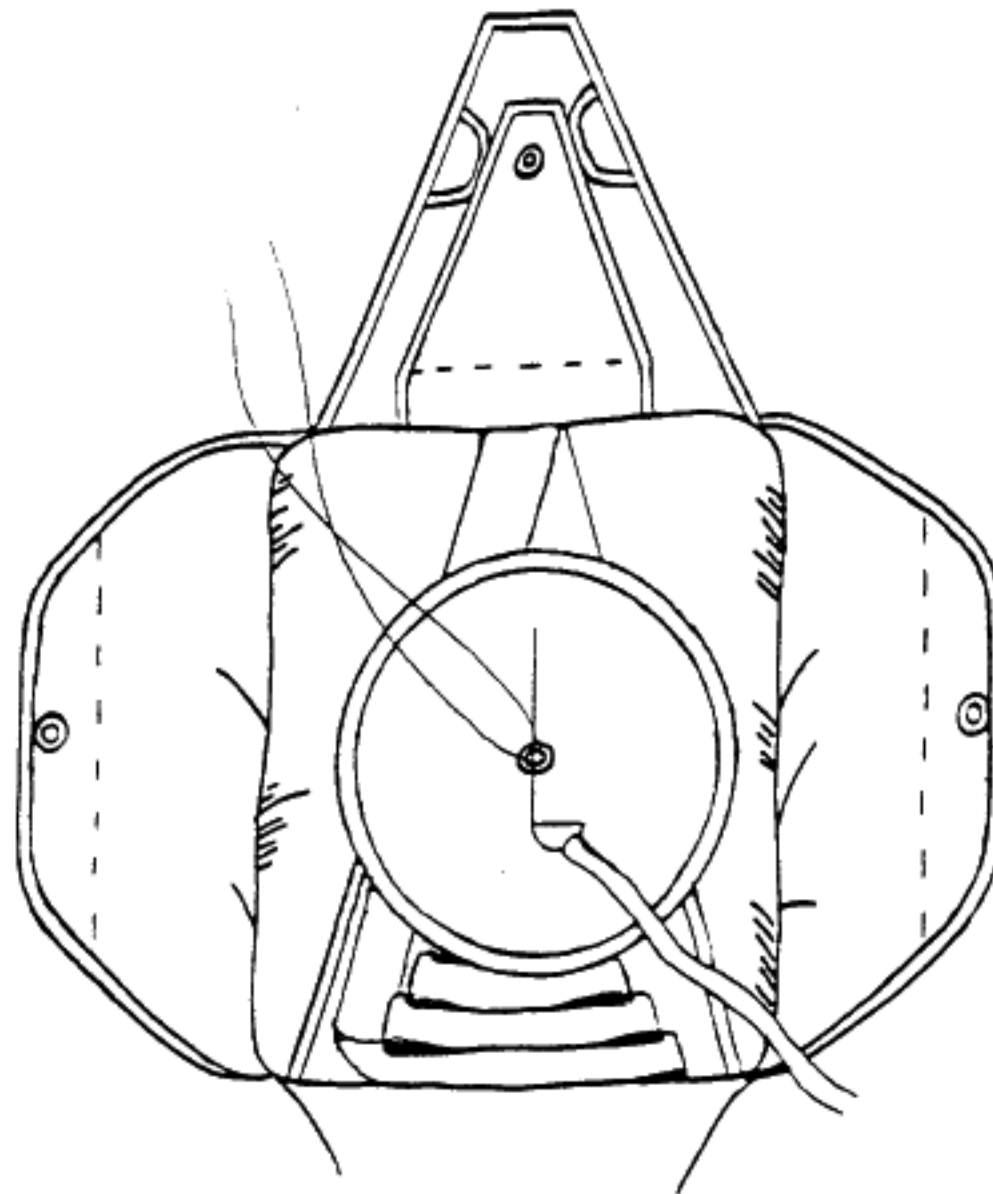
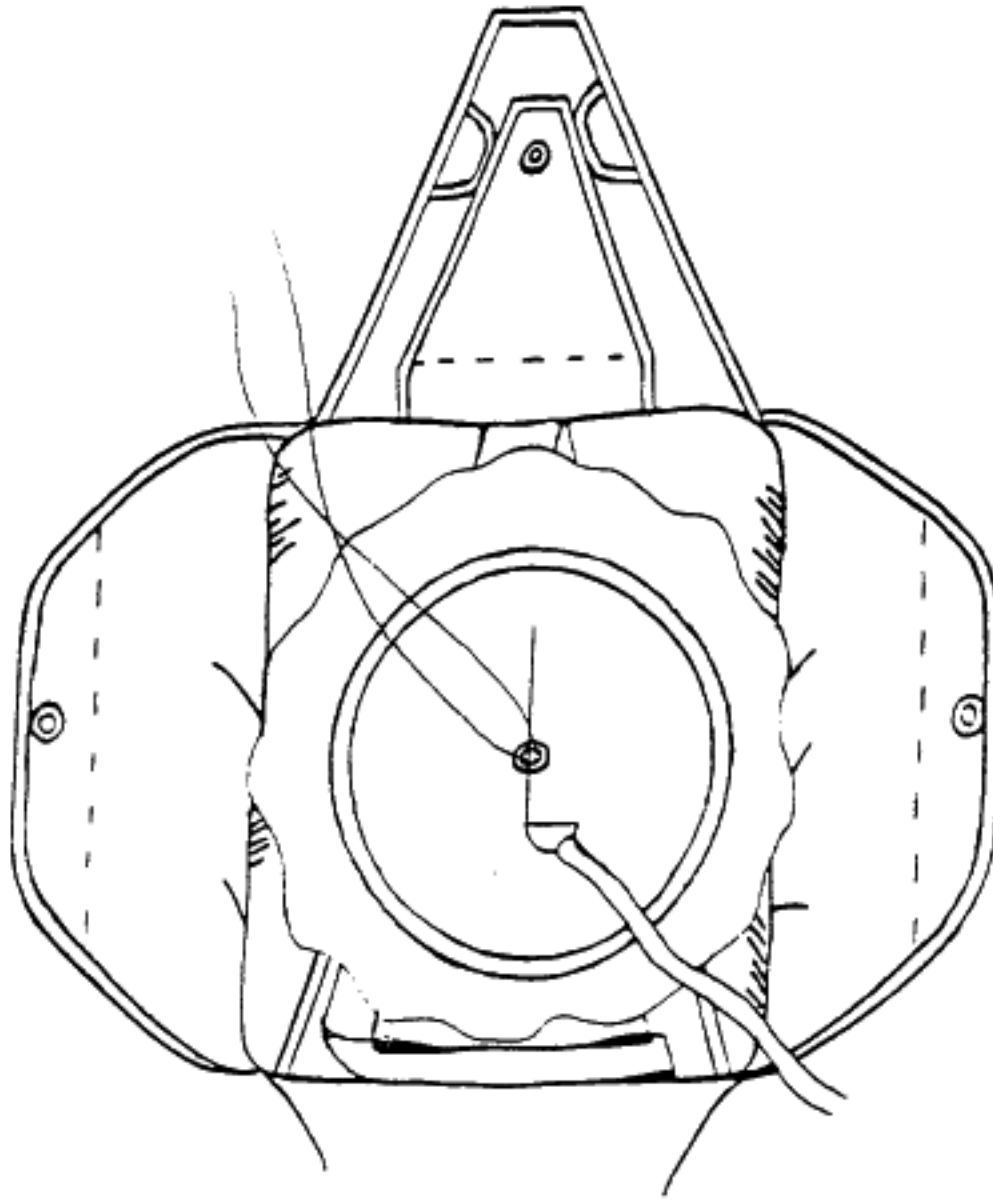

8. Close side flaps (**THE RIGHT ONE FIRST**) and reinstall the temporary pin.

9. Dress the upper corners of the container.

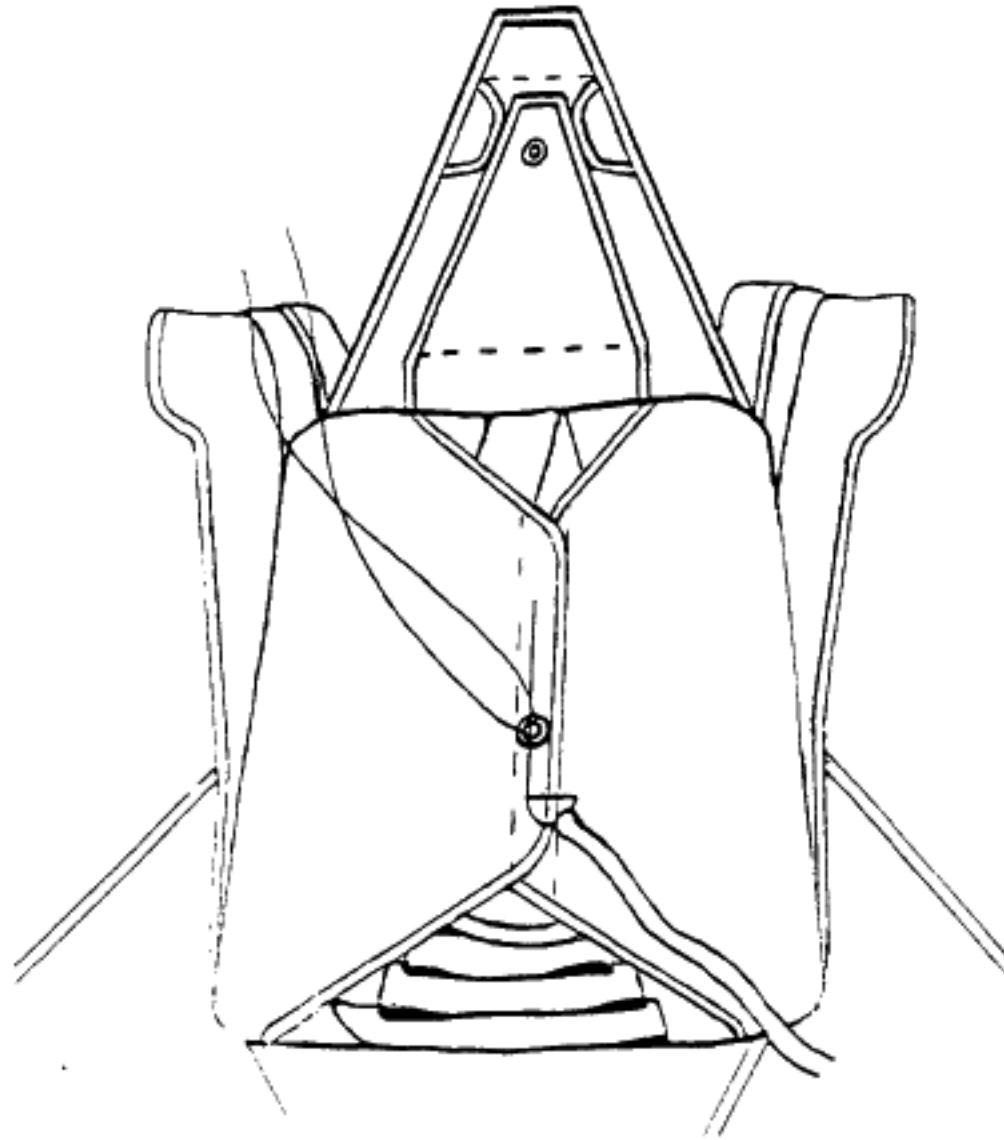

10. Close the inside top flap.

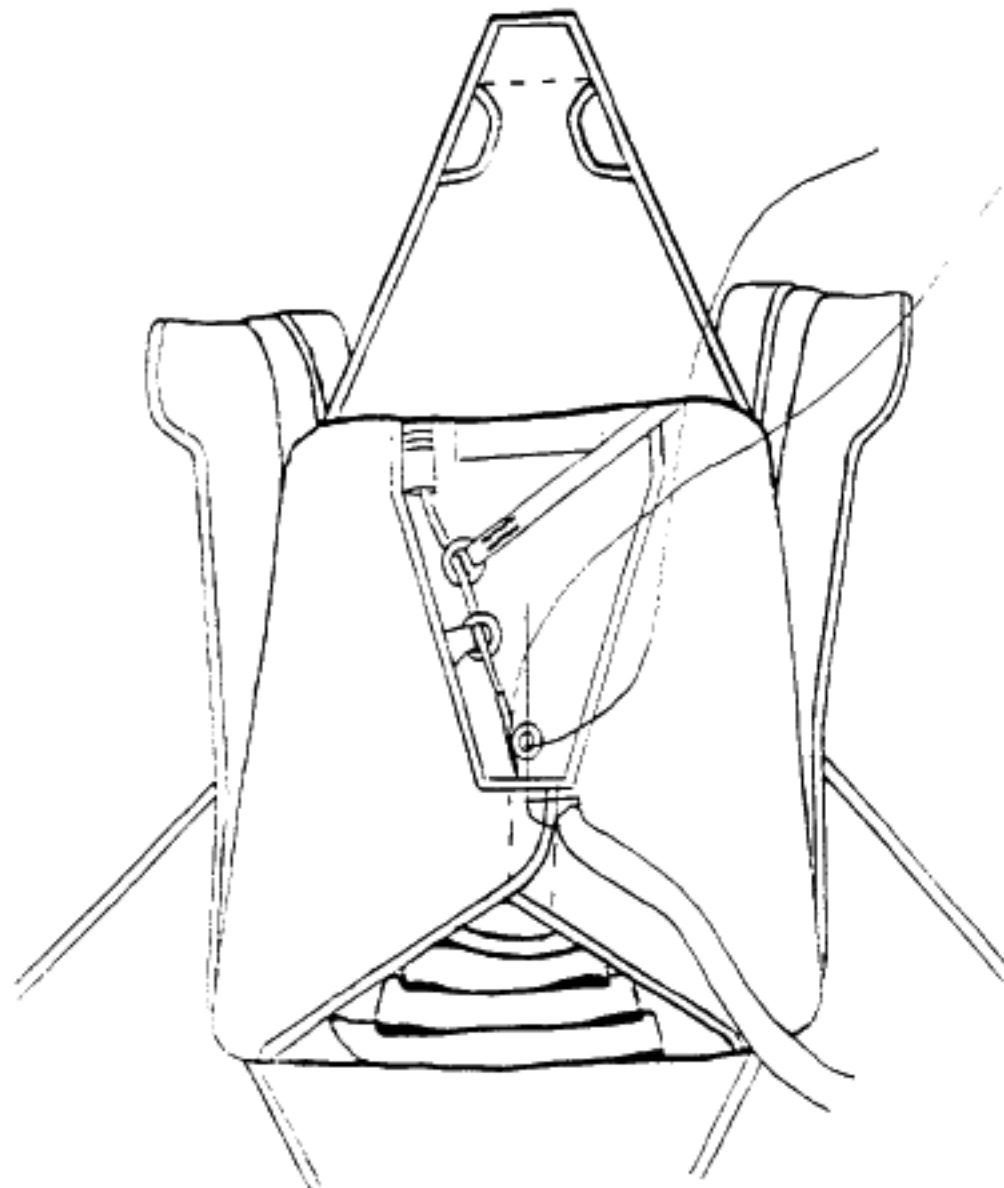

11. Close the center flap. **Remove the temporary pin**, pull up the closing loop and insert the ripcord pin. You should not be able to pull up more than  $\frac{1}{4}$  inch of loop.
12. **INSERT THE RIPCORD PIN INTO THE PIN-PROTECTOR POCKET ON BOTTOM FLAP.**

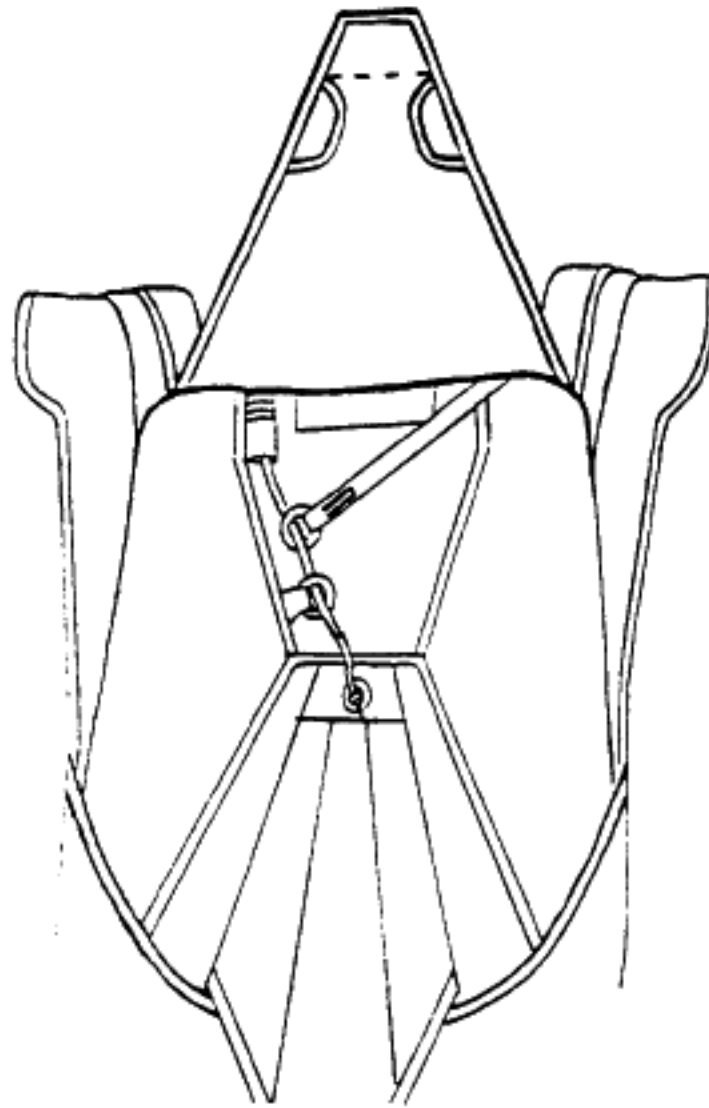

13. At this time, verify that the tension on the reserve pin is within specifications and that the appearance is acceptable.

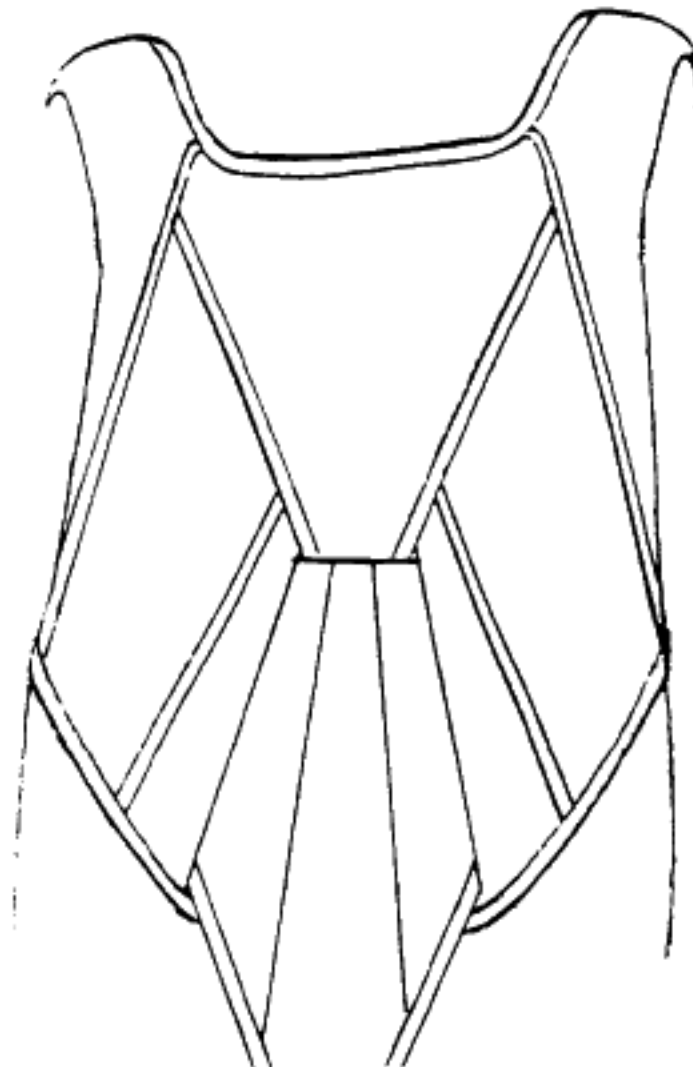

14. Sign packing data card (previously filled out) and insert it in the pocket provided behind the left ring cover.
15. Redress corners if necessary. Install seal in the normal manner, close the top cover flap, and secure it with the tuck-in tabs. Tuck the outer top flap into the lower reserve flap.
16. **RECHECK THIS PROCEDURE TO ASSURE THAT ALL STEPS WERE COMPLETED AND THEN COUNT YOUR TOOLS TO BE ABSOLUTELY SURE THAT THEY ARE ALL OUT OF THE CONTAINER!**

## CYPRES

**NOTE: THE FOLLOWING IS NOT MEANT AS AN INSTALLATION GUIDE.  
REFER TO AIRTEC DOCUMENTATION FOR FURTHER DETAILS.**

The INFINITY harness/container is manufactured with an approved CYPRES set-up. Should one be encountered without the set-up, contact Velocity Sports Equipment for the approved installation procedures.

If you are installing a CYPRES AAD or packing an INFINITY with a CYPRES AAD installed, refer to the AIRTEC documentation for proper procedures.

## **INFINITY Reserve Supplemental Lanyard**

The *INFINITY* is delivered with a Reserve Supplemental Lanyard (RSL) as a standard feature. Attaching the RSL is entirely optional, depending on personal preference. The RSL is a simple device that may activate the reserve ripcord immediately after disengaging (via the 3-Ring release mechanism) from the main parachute. This action must be taken at an altitude sufficient for the proper functioning of the reserve parachute. The RSL is designed not to interfere with the manual activation of the reserve.

In cases where the immediate activation of the reserve is not desired, the RSL is equipped with a quick release mechanism (snap shackle), allowing the user to disable the RSL prior to disengaging from the main. The snap shackle is located at the lower end of the right side main riser via a small ring. To disengage the RSL, simply pull on the red tape attached to the snap shackle.

**Remember, if the RSL is attached to the riser when you disengage from the main, you may activate the reserve!**

Ask an instructor or knowledgeable rigger for those situations where the use of an RSL may not be advised.

### **CAUTION**

The RSL is a dependable system; however, it is only a backup. It should never be relied upon solely for the activation of the reserve. In the event of a cutaway situation, the jumper should make every attempt to pull the reserve handle as if there were no RSL present.

The RSL **will not** operate in the event of a total malfunction of the main (No main parachute out).

## ASSEMBLING THE RSL

There is one small ring mounted on the reserve top flap near the end of the ripcord housing. Insert the reserve ripcord into the housing. After it exits the housing, pass the ripcord through the ring on the end of RSL, then through the second ring on the flap.

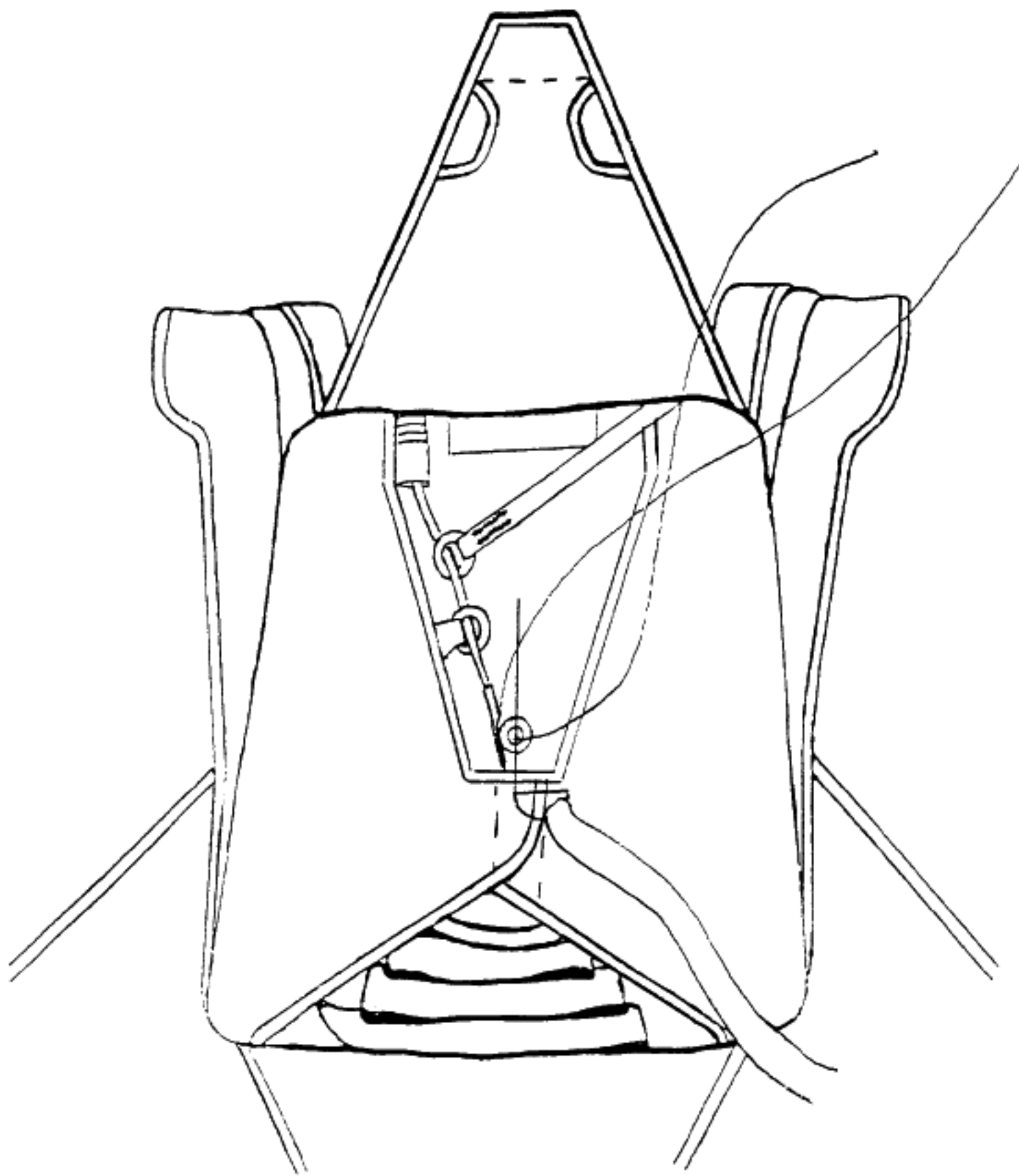

After the reserve container is properly closed and sealed, route the RSL to the right reserve risers. Peel the reserve risers away from the yoke of the rig to reveal the channel for the RSL. Unroll the channel and place the RSL inside, then roll the channel back up. The snap shackle should exit from under the reserve risers on the same side it entered. After the main riser is attached to the harness, connect the snap shackle to the main riser at the small ring on the rear inboard side of the riser. There should be sufficient slack in the RSL to allow the main riser to move in all directions, without applying any pressure on the reserve ripcord pin.

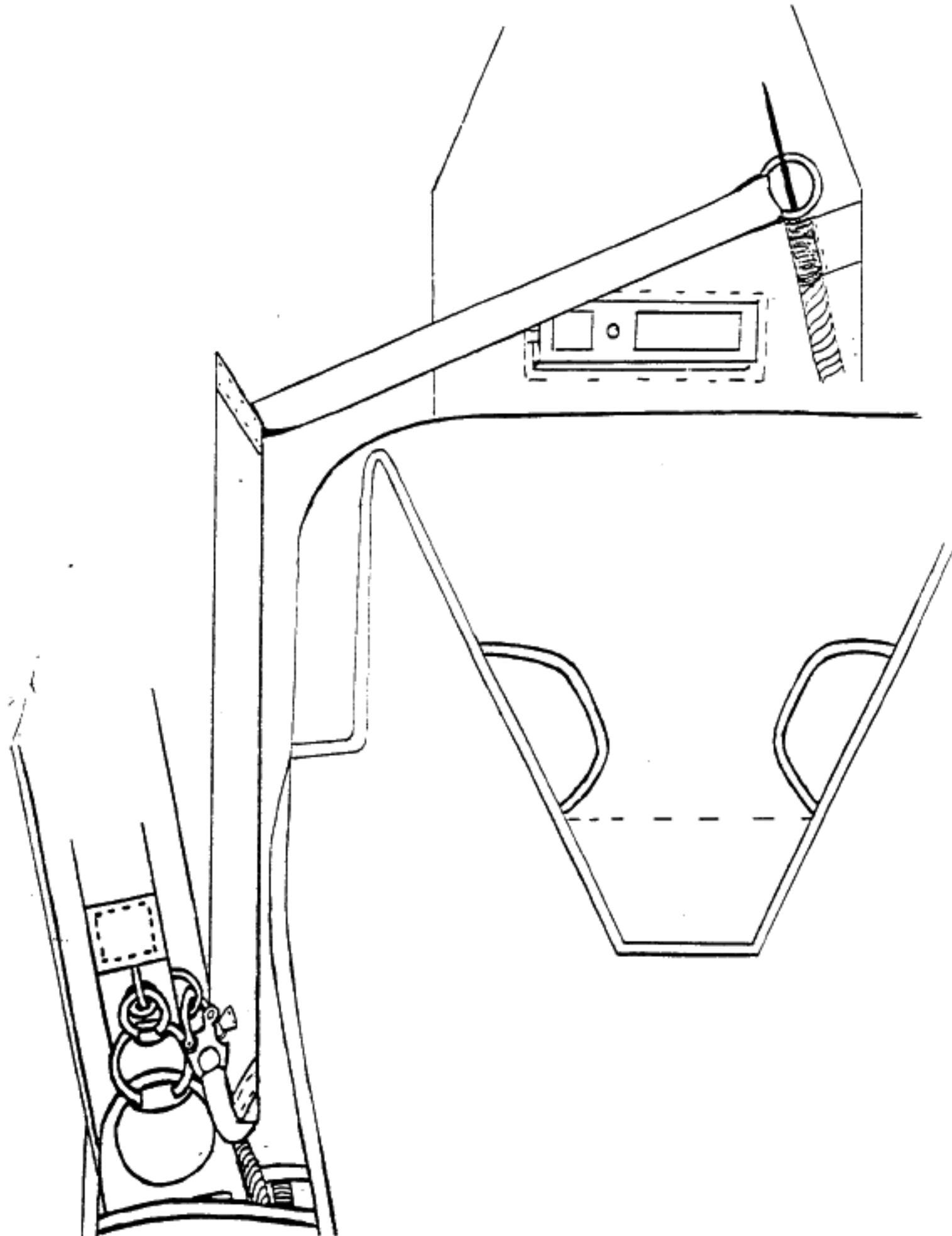



# The 3-Ring Release

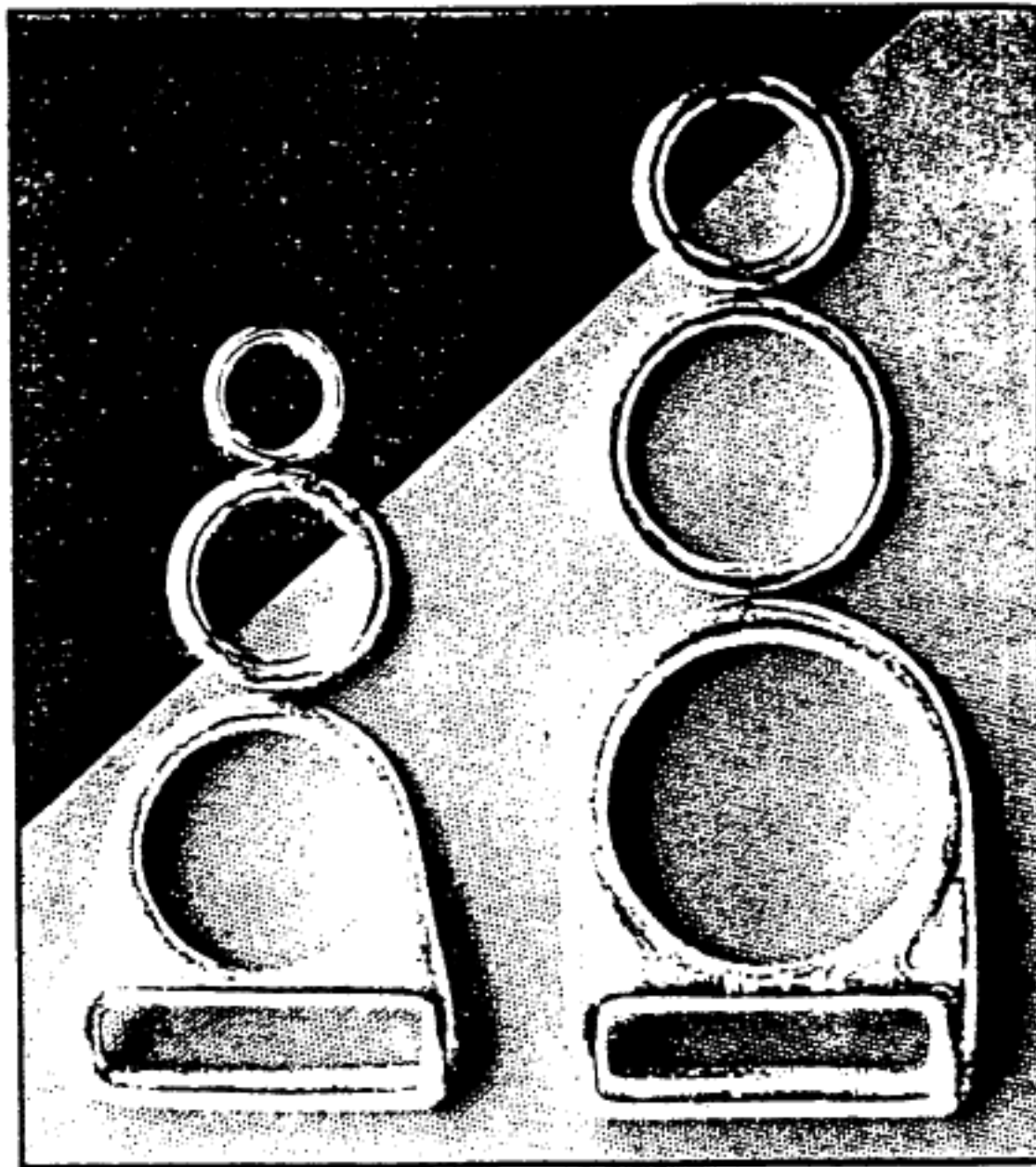

This section reprinted courtesy of THE RELATIVE WORKSHOP INC.

## ASSEMBLY

Before assembling the 3-Ring release, make sure the risers aren't twisted or reversed. Lay the **INFINITY** face down, as you would to pack it.

1) Thread the cable into its housing and stick the handle to the harness. The handle should be positioned as close to the ends of the housings as possible so that no cable is exposed.

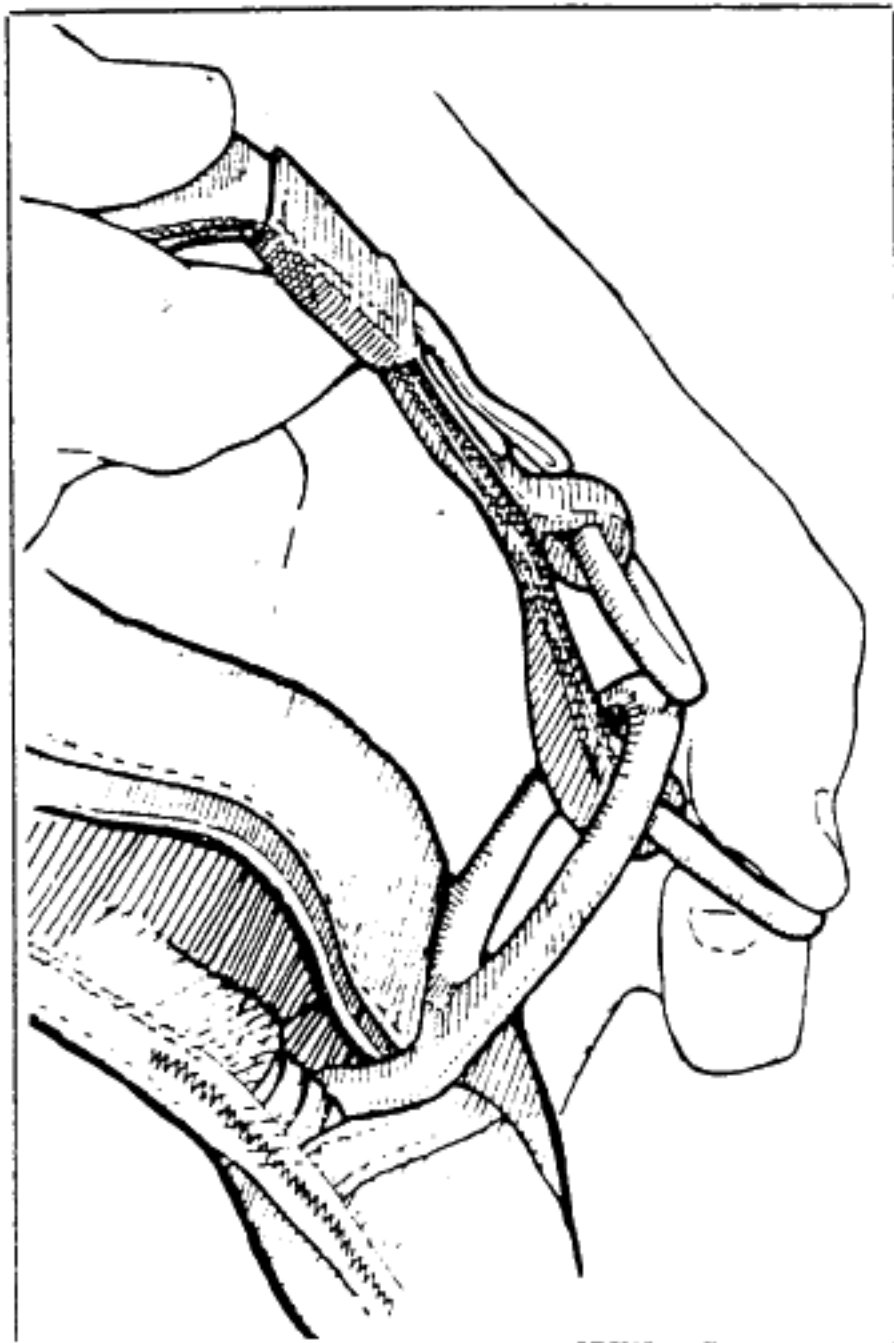

2) With the rings of the riser facing toward the floor, pass the ring on the end of the riser through the large harness ring from above. Fold it back toward the canopy and risers.

3) Thread the smallest ring through the middle ring in the same way, but make sure it doesn't pass through the large ring.

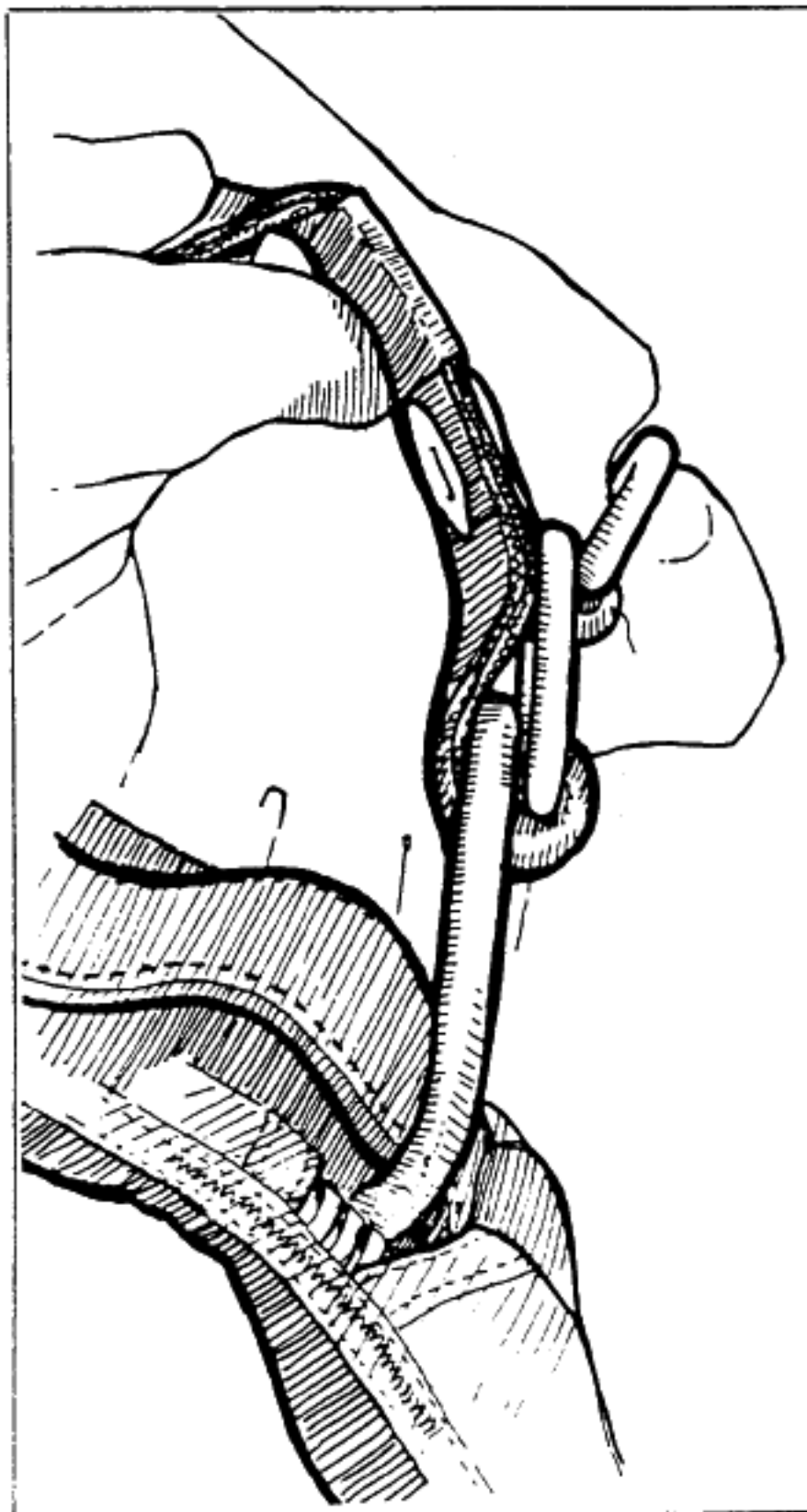

4) Bring the white loop over the small ring only and then through the riser grommet so it pokes out the back of the riser.

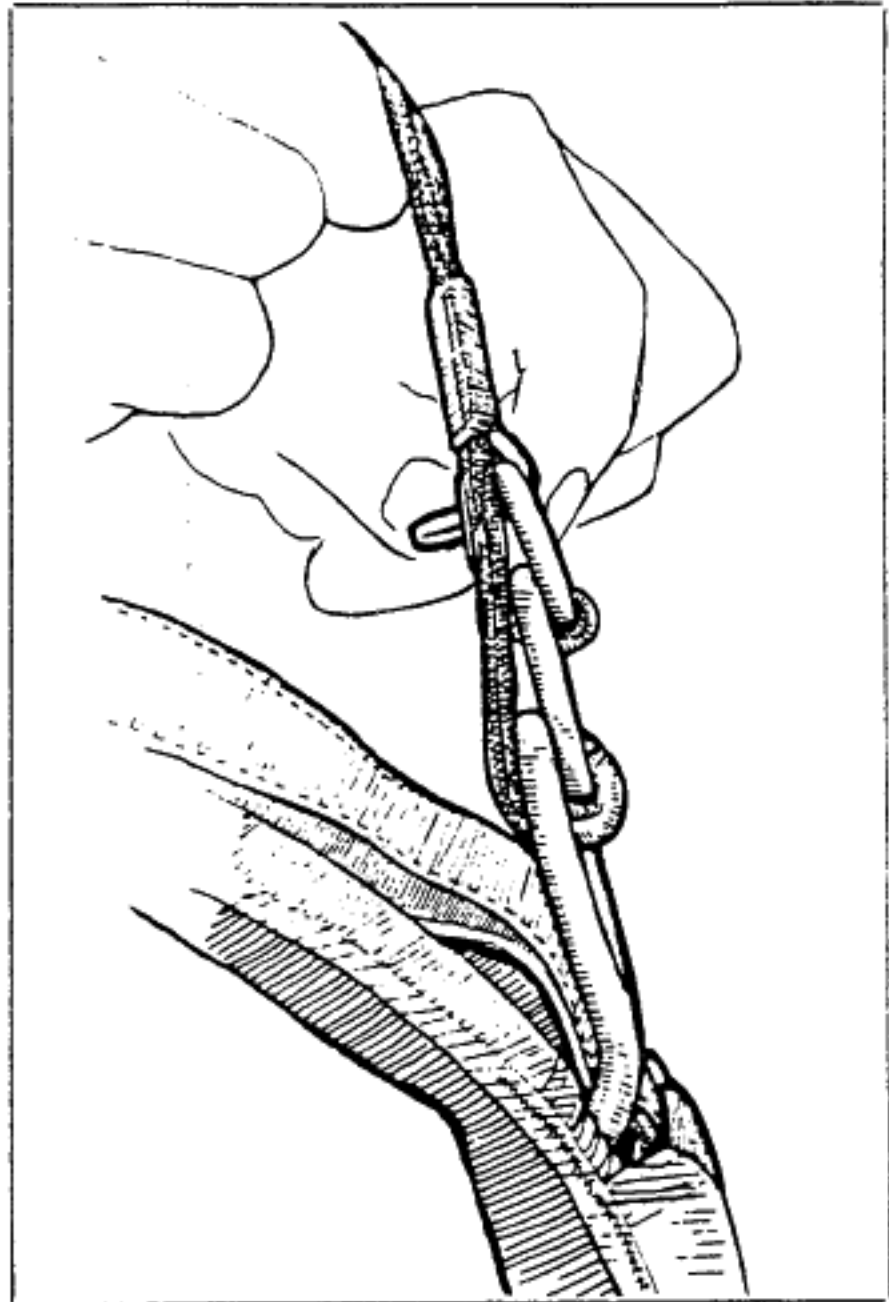
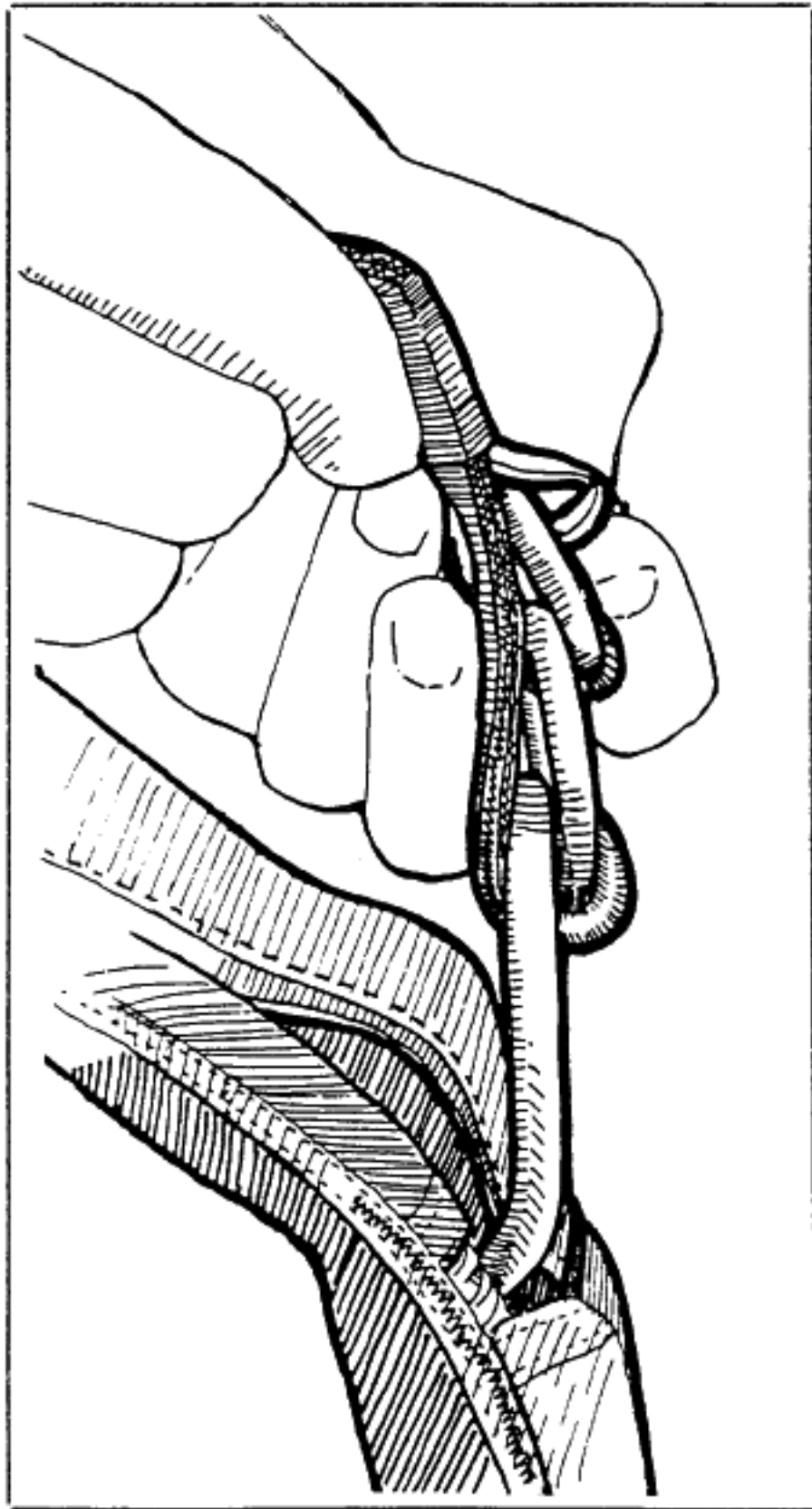

5) Continue threading the white loop through the grommet on the end of the cable housing. The flat side of the cable housing grommet should be against the riser.

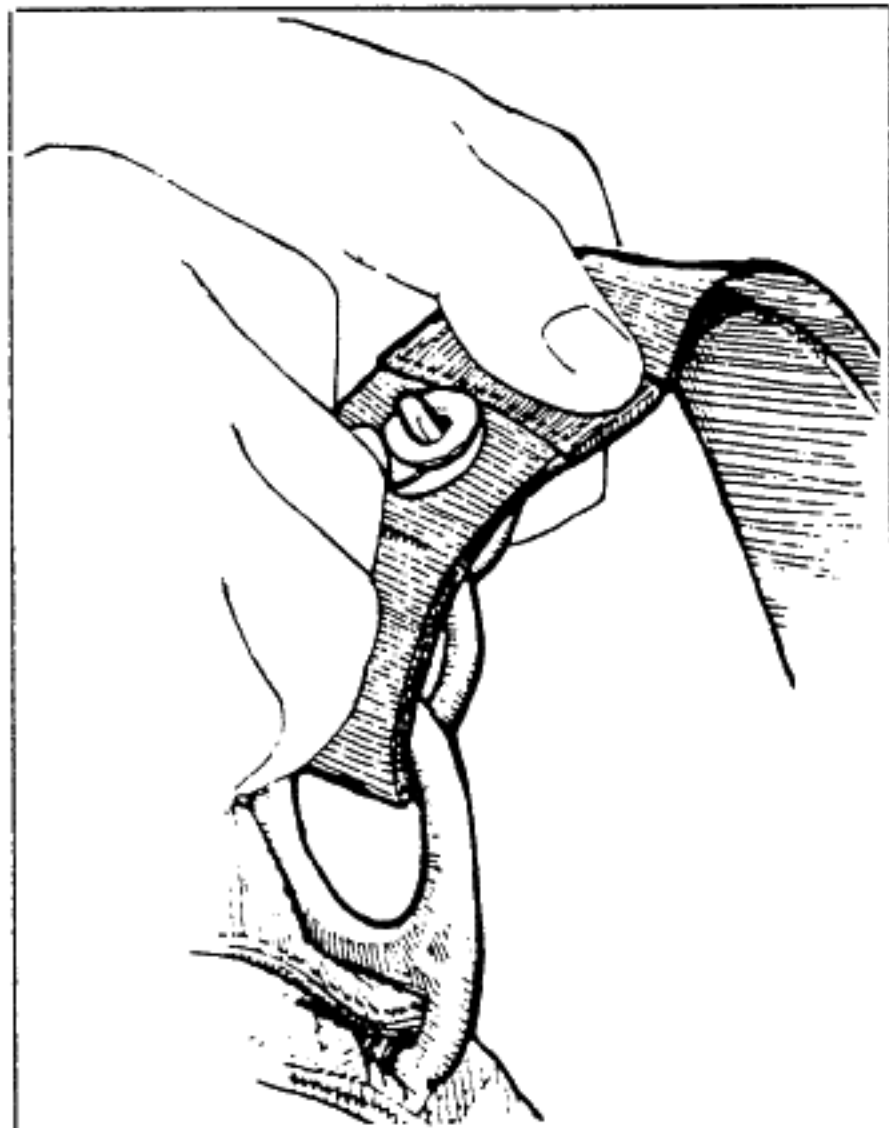

6) Thread the yellow cable through the white loop, making sure the loop isn't twisted. Be careful with the cable so you don't bend it too sharply or kink it. Insert the free end in the channel on the back of the riser.

7) Repeat the above steps with the other riser.

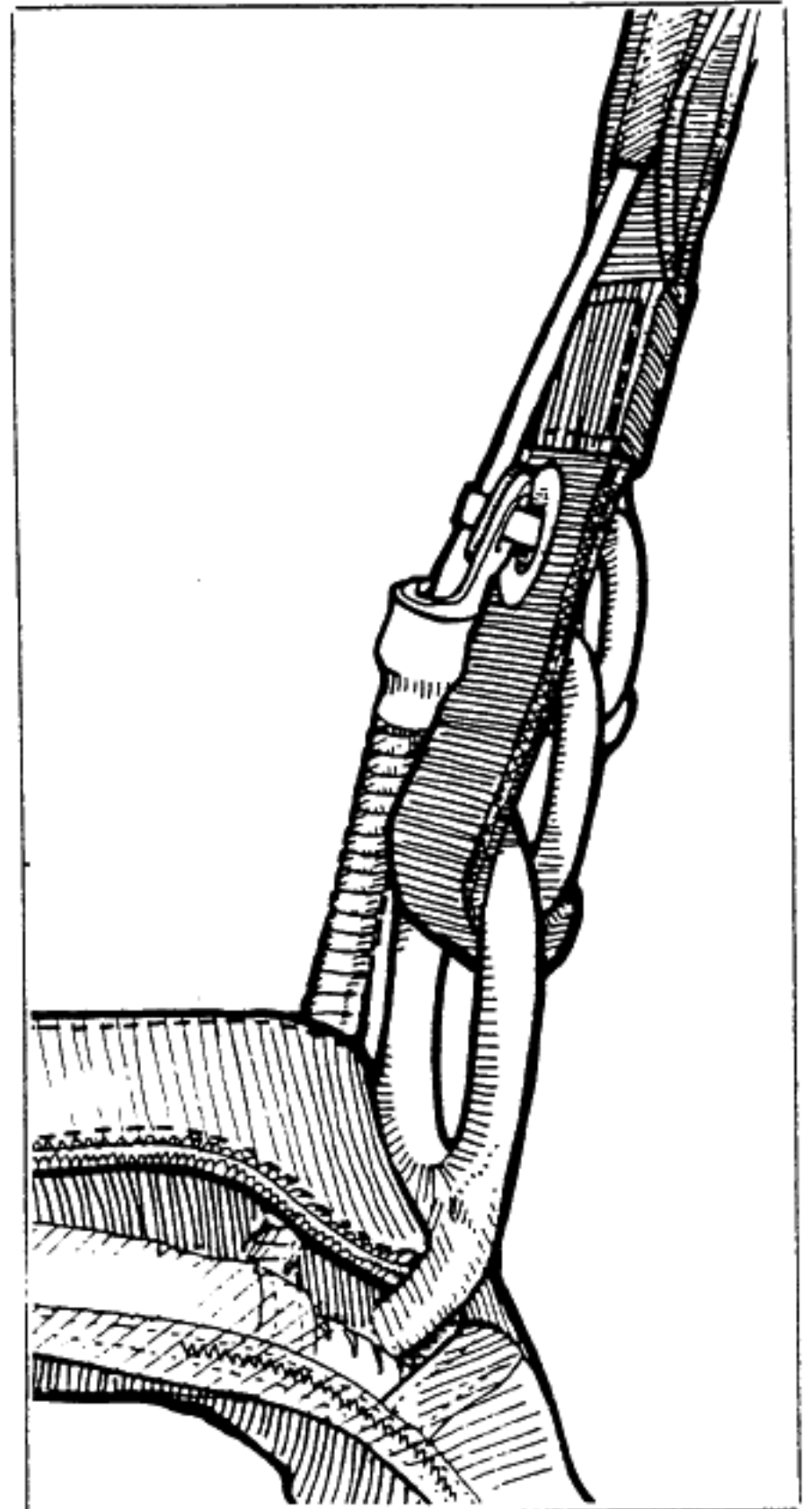
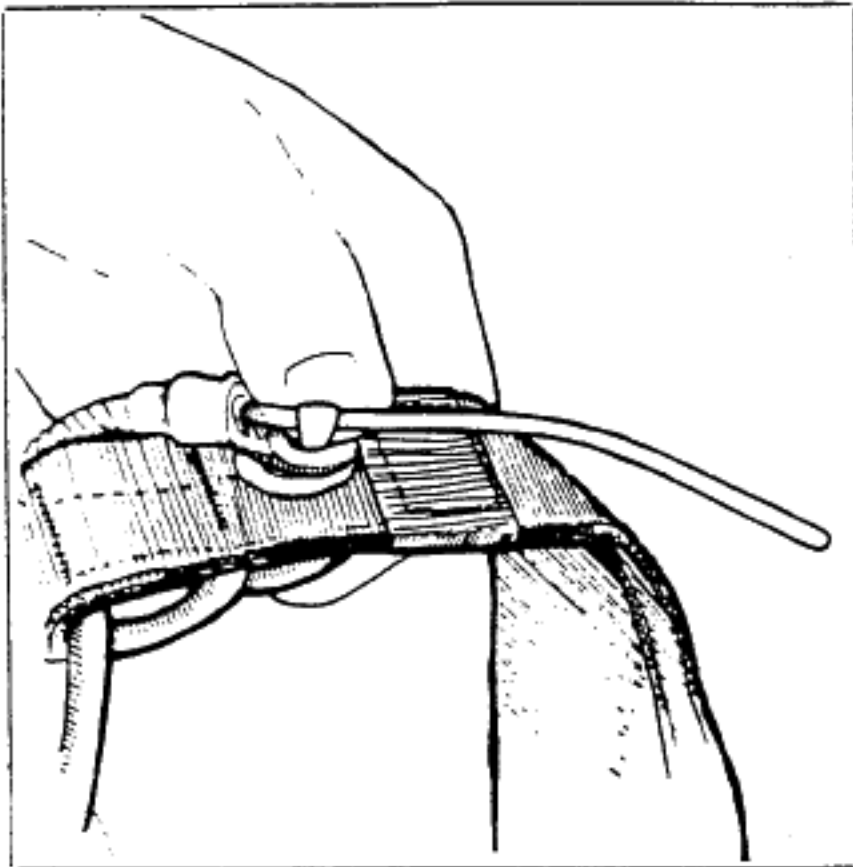
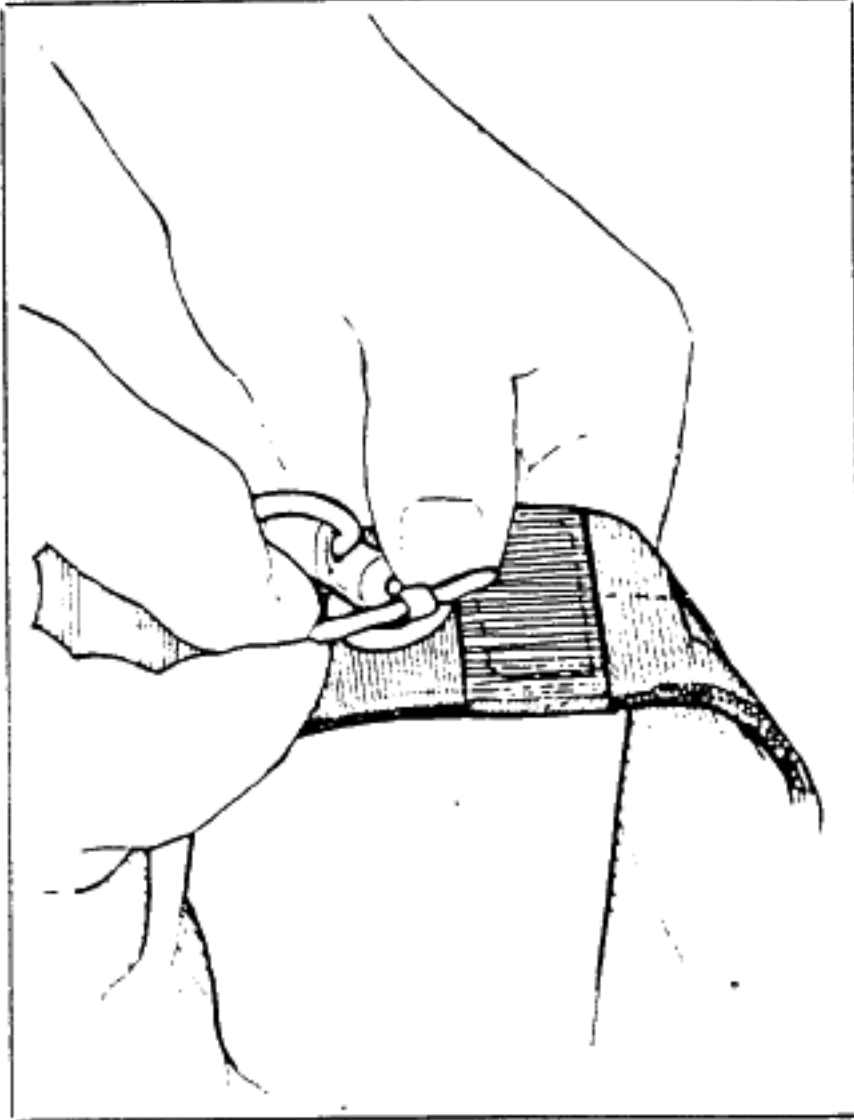

## REQUIRED PERIODIC MAINTENANCE FOR THE 3-RING

The Booth 3-Ring Release System has been in use for many years with excellent results. Although the system is as durable as the rest of the harness/container assembly, it requires periodic maintenance and inspection to ensure proper operation.

Generally it is NOT recommended that the risers be attached to the harness when new and "forgotten." Like all skydiving gear, the 3-Ring Release should be carefully inspected and operated on a regular basis.

The procedures below should be done at least every month. This is especially important if the rig has not been used for a month or more, such as during the winter. Immediate inspection is required if it has been subjected to some abuse such as a drag across the runway, a water landing or exposure to a lot of dust or sand.

- 1) Every month operate the 3-Ring release system on the ground. Extract the cable completely from the housings and disconnect the risers.
- 2) While the system is disassembled, closely inspect it for wear. Check the white locking loops (the ones that pass over the smallest ring and through the grommet) to be sure they are not frayed.
- 3) Check the Velcro on the breakaway handle and main lift web to be sure it is clean and adequately holds the handle.
- 4) Check the cable ends for a smooth finish. The ends are finished at the factory to have a smooth, tapered surface. This prevents the cable from hanging up in the loop. Check the cable ends and consult a rigger or the manufacturer if a burr or "hook" is present.
- 5) Check the stitching, including that which holds the large rings to the harness.
- 6) Pull downward on the housings. They shouldn't move downwards more than  $\frac{1}{2}$  inch.

- 7) Take each riser and vigorously twist and flex the webbing near where it passes through each ring. The idea is to remove any set or deformation of the webbing. Do the same thing to the white loop. (See drawing, next page.)
- 8) Check the housings for dents or other obstructions. Use the cable to do this.
- 9) Clean and lubricate the release cable with a light oil such as a "3-in-1" brand. Put a few drops on a paper towel and firmly wipe the cable a few times. A thin, invisible film should remain--too much will attract grit and dirt, or the oil could become tacky in cold weather. Too much oil will require more force to extract the cable during a breakaway.
- 10) Inspect the fittings at the end of each housing. If one of these fittings were to come off the housing, a riser might release prematurely.
- 11) If any wear is found, consult a rigger or the manufacturer before using the **INFINITY**.
- 12) Reassemble the system. Double check it. Make sure the risers aren't reversed.

It's important to maintain the system even more frequently in humid, muddy or freezing conditions. If the **INFINITY** becomes immersed in mud or muddy water, clean the 3-Ring release system with a mild solution of soap and water. Any rusted components must be replaced.

