

OWNER'S MANUAL
for the Packing and Maintenance of
PARA-CUSHION
EMERGENCY PARACHUTES

With Strong Military Lopo, Lopo, Midlite, and Lite Canopies

Para-Cushion Back Model 303

Para-Cushion Seat Model 304

Para-Cushion Chair Model 305

Part Number 1045-()

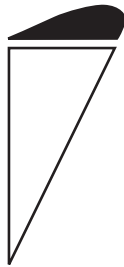

STRONG ENTERPRISES

11236 SATELLITE BLVD.

ORLANDO, FL 32837

Tel (407) 859-9317

Fax (407) 850-6978

E-mail: Sales@strongparachutes.com

www.strongparachutes.com

THE PARACHUTE COMPANY WITH IMAGINATION

Manual P/N 510048
Price \$5.00

Rev. F, 4/1999

DISCLAIMER NO WARRANTIES

There are no warranties which extend beyond the description of the parachutes in this manual, and neither the seller nor any agent of the seller has made any affirmation of fact or promise with respect to the parachute except those that appear therein.

The liability of the seller is limited to the duty to replace defective parts found upon examination by the manufacturer to be defective in material or workmanship within seven days after purchase and found not to have been caused by any accident, improper use, alteration, tampering, abuse or lack of care on the part of the purchaser.



Even though the parachutes described in this manual are intended to be a life-saving devices, There is no guarantee that they will work if needed.

There are so many factors both human and natural beyond our control that we want you to clearly understand that by using or intending to use our parachutes, you are assuming a considerable risk of personal **INJURY OR DEATH.**

If you are not willing to assume that risk, please return the parachute to the dealer where it was purchased for a full refund.

Contents

Page	Topic
2	Disclaimer
3	Contents
4	Scope
4	FAA Approval
4	Operational Limitations
4	Repack Cycle
4	Description
5	Model Identification
6	System Function
6	Care of Your Para-Cushion
7	Service Life
7	Using the Para-Cushion
7	Preflight Inspection
7	Fitting the Para-Cushion
8	Plan Ahead
8	How to Get Out of the Aircraft
8	How to Open Your Parachute
8	How to Steer
9	How to Land
9	Recovery
10	Component Chart
12	General Assembly Instructions
14	General Packing Instructions
17	303 Back
23	304 Seat
29	305 Chair
35	Repair Guidelines
36	Canopy Specifications Chart
37	FAA TSO Approval Letter
38	Notes

SCOPE

This owner's manual constitutes the manufacturer's instructions for the operation, packing, and maintenance of the Para-Cushion series of emergency parachutes. This series includes three systems: the Para-Cushion Back, Para-Cushion Seat, and Para-Cushion Chair, including variations of each.

FAA APPROVAL

Originally certified in 1973 under TSO C-23b, standard category, the Para-Cushion parachute assemblies were upgraded in 1992 and are now FAA approved under TSO C-23c, category B (in accordance with AS 8015A and FAR 21, Subpart O). A copy of this approval is on page 37.

OPERATIONAL LIMITATIONS

Limited to use by persons up to 115 kg (254 lbs) fully equipped (person, clothes, and equipment except parachute), and up to 150 knots IAS. (Maximum recommended weight, (wearer, clothes, equipment) of 175 pounds (79.5 kg) if the LITE canopy (Part No. 1012-6) is installed.)

REPACK CYCLE

Your Para-Cushion is subject to a 120 day repack cycle. FAR 91.15 requires that "no pilot of a civil aircraft may allow a parachute that is available for emergency use to be carried in that aircraft unless it is an approved type and....it has been packed by a certificated and appropriately rated parachute rigger within the preceding 120 days." Your Para-Cushion Back or Para-Cushion Chair must be packed by an FAA Senior or Master parachute rigger with back type rating. The Para-Cushion Seat must be packed by an FAA Senior or Master parachute rigger with a seat type rating. If your Para-Cushion is subjected to moisture or damage it should be inspected sooner than the 120 day maximum.

DESCRIPTION

The Para-Cushion is an FAA approved manually operated emergency parachute system fitted with a round 26-foot diameter, steerable canopy. The Para-Cushion series includes back, seat, and chair types and several variations of each. Briefly, the newer version of the back type (the 303, introduced in 1987), has fabric riser covers and is slightly shorter than the original Para-Cushion Back. The newer version of the seat type (the 304, introduced in 1988), has fabric riser covers and is slightly taller than the original Para-Cushion Seat. The Para-Cushion Chair (305) combines the best features of both the back and seat types and extends all the way from shoulders to thighs on the wearer. The unique arrangement (U.S. Patent #3,908,937) of each system with its externally mounted pilot chute allows for a soft flexible container with protected ripcord pins.

The Para-Cushion models are easily identified using the following chart:

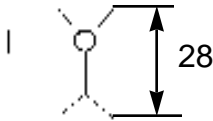
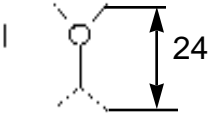
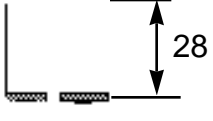
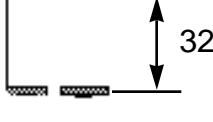
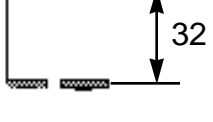
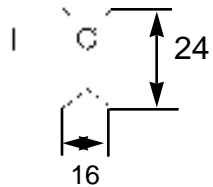
Type	Model	Configuration	FAA Part No	SE Part No.
Back	Original		1045-2	
Back	303		1045-2	124105
Seat	Original		1045-1	
Seat	304		1045-1	121105
Seat	304/C9		1045-1	121102
Chair	305		1045-3	124255

Each complete system weighs between 14 1/2 and 15 3/4 pounds depending upon model, and the canopy used. This manual covers Para-Cushions packed with the following emergency canopies manufactured by Strong Enterprises: the 26-foot Standard Lo-Po, the 26-foot Military Lo-Po, the 26-foot Mid-Lite and the 26-foot Lite. All four canopies utilize low porosity (Lo-Po) cloth which allows less air flow, and therefore a slower, more stable rate of descent than conventional parachute cloth.

NOTE

The 120 day repack cycle required by regulation is a maximum. If for any reason your parachute is not in the condition it was when packed, it should be inspected and repacked, regardless of the time since previous packing.

SYSTEM FUNCTION

The Para-Cushion is activated by pulling the ripcord handle. This withdraws the ripcord pins and releases the locking loops allowing the pilot chute to eject, catch air and extract the parachute canopy from the container. The canopy is packed with a device called a “diaper” which is sewn to the skirt at the bottom of the canopy and is where some of the suspension lines are stowed. The balance of the lines are stowed inside the container. On deployment, as the canopy is extracted from the container, the lines are also deployed from the container.

When the last stows deploy, the diaper is released allowing the canopy to inflate. The total time for deployment and how far you travel from pulling the ripcord to a full open canopy depends very much on your airspeed. Generally, opening times are from 2 to 3 seconds and the distance fallen would be from 150 feet to 300 feet. This does NOT mean that you should plan on jumping or pulling at 300 feet.

CARE OF YOUR PARA-CUSHION

Parachutes are simultaneously very rugged and quite delicate. They are pieces of life saving equipment and should be treated with care. Parachutes are made of nylon, a very strong and durable material, but even nylon has enemies. Small amounts of acid will eat it and ultra-violet sunlight weakens nylon rapidly. This is a surface effect so that thicker material, such as webbing or pack material are not seriously affected, but canopy cloth is very vulnerable. If your Para-Cushion is opened or used, it should be taken to a certified parachute rigger, parachute loft or returned to the manufacturer for airing, drying, inspection and repack. FAR 65.129 requires that no parachute be packed, maintained, or altered in any manner that deviates from procedures approved by the manufacturer.

The parachute should be left unopened inside its protective container ready for use. When you take your Para-Cushion to your rigger for servicing, they will be glad to allow you to pull the ripcord yourself, give you a functional demonstration, and answer all your questions. We urge you NOT to open your parachute in the field for demonstration purposes. Foreign objects can damage the canopy which will require repairs at your expense.

When your Para-Cushion is in the aircraft care must be exercised to assure that it is not damaged. Be sure that it does not come in contact with any sharp or loose metal surfaces, or any objects within the plane which might cut or snag it. All metal edges and exposed nuts and bolts, etc. should be taped or covered to prevent wear on the parachute container. Be sure that your parachute does not come in contact with water, oils, acids, grease, dirt, agricultural or fire retardant chemicals. When not in use, store your Para-Cushion in its carrying bag in a clean, dry, protected area. If in doubt as to its condition, consult your nearest parachute rigger, parachute loft, or Strong Enterprises.

CAUTION

**NEVER STORE YOUR PARACHUTE IN YOUR COCKPIT
EXPOSED TO THE SUN**

SERVICE LIFE

Strong Enterprises and other members of the Parachute Industry Association (PIA) are currently discussing guidelines for a recommended service life. FAR 65.129 requires that “No certificated parachute rigger may pack a parachute that is not safe for emergency use,” so until guidelines are established, the continued airworthiness of an assembly is established by the licensed parachute rigger who inspects it as part of his repacking procedure. While proper care can no doubt extend its usefulness, an older parachute should be examined more closely for signs of deterioration. Your parachute should be treated as the sensitive piece of life saving equipment that it is, but it should not be expected to last forever, even when proper care is taken.

USING THE PARA-CUSHION**PREFLIGHT INSPECTION**

Prior to each flight the parachute should be inspected before it is put on. Check it visually for any unsafe condition. Be sure the harness is not twisted or misrouted. Are the fittings rusted? Did it get oily on the hanger floor? Is the ripcord handle secure in its pocket (under the fabric pocket covering)? Lift the velcro on the back pad (unzip the seat pad on the seat model) and check the ripcord pins to be sure they are properly seated in their loops. All pins should extend at least 1/2 inch beyond the fabric locking loop. Be sure the rigger’s seal thread is still intact around the last pin. That’s your assurance it has not been opened since it left the rigger’s packing table. Check the packing data card in the nearby pocket to be sure that the parachute has been repacked within the previous 120 days.

FITTING THE PARACHUTE

If you’re putting the parachute on for the first time, unsnap the straps, loosen all adjustment points, slip your arms through the main lift web (the vertical straps in front), much like putting on a jacket. Next, reach between your legs, pick up each leg strap, untwist them if necessary, and snap them in place on each side of the lower portion of the main lift webs. Lean forward, pull the leg straps below your hips, and tighten them snugly, yet comfortably, around your thighs. Finally snap and adjust the chest strap. Fold and stow the webbing ends in the elastic keepers. Be sure the ripcord handle is accessible.

Many Para-Cushions have adjustable main lift webs, (vertical straps that come down over your shoulders) and back straps, that will allow you to adjust fit of your harness. To adjust these straps, stand at attention, adjust the main lift webs so that both sides are even and they are just tight enough so you have barely enough room to stand upright. This will feel tight when standing up, but you should find it comfortable when seated. Resist the urge to excessively tighten the harness while seated, this could restrict your escape from the cockpit. The back straps, if adjustable, should be the same length as the distance between the container and your lower back while you are standing upright.

PLAN AHEAD

Know and rehearse your emergency procedures before they are needed to reduce your decision making time. With the parachute on, sit in your cockpit and fasten your lap and shoulder belts. Be certain these are over your parachute harness. Wear gloves, helmet and goggles, even headphones if you normally use them. Mentally organize your bailout procedure. Inspect your cockpit for projections or sharp edges that may damage the parachute, or injure you. Consider canopy ejection, oxygen disconnect, or other requirements that you may be faced with. All these things take time, and an emergency leaves you little time for rehearsal. Generally, you are better off staying with the ship if its controllable, but the time you spend evaluating that, reduces your margin of safety, and in some cases the condition can get worse. Make your decision quickly because all these actions consume altitude.

HOW TO GET OUT OF THE AIRCRAFT

It boils down to two things: Get clear of the aircraft, then pull your ripcord. In that order. If the parachute begins to open while you're still aboard, the wind may inflate it, dragging you out, or into the tail. Also, it may entangle with the aircraft. There are no other hard or fast rules—the craft may be tumbling, spinning, or inverted. Simply get yourself out any way you can. Unless you're above 15,000 feet, pull your ripcord to open your parachute immediately, once you're clear. There is enough oxygen to breath, and you'll be descending into more dense air all the time, plus it gives observers an opportunity to get a fix on your position.

HOW TO OPEN YOUR PARACHUTE

The ripcord handle is located near the chest strap on the wearer's left front of the harness. The key is to **LOOK** at the ripcord handle, rather than fumble or tug on a harness fitting. Beneath the fabric cover the handle is held in place by a pocket but it may have been dislodged by your exit, so look for it first. **REACH** over and grab it with both hands (or typically with your right hand and left thumb), and **PULL: YANK IT HARD**. This is no time to be gentle! Actually pulling, which uses the muscles of your forearms, is not as effective as pushing, which takes advantage of your upper arm strength. If it doesn't come free on the first pull, check to make sure you have the handle in you hand, back the handle up to the housing to create slack in the cable, then punch it out again. The entire cable assembly should come completely out of the housing. To reduce the pull force, push it in the direction that the protective ripcord housing points rather than straight out from your chest. The Para-Cushion Seat container has a housing coming from under you, so pull the handle straight up, over your head. The Para-Cushion Back and Para-Cushion Chair both have housings coming over your shoulder, so push the handle down toward your feet. By having both hands together on the handle, you also reduce the chance of the canopy or lines entangling with an extended limb. Keep your feet together for the same reason. Body position is secondary to pulling. Remember to **LOOK-REACH-PULL**.

HOW TO STEER

Having a steerable parachute reduces your rate of descent, increases your stability, and allows you to avoid obstacles (buildings, trees, water, power lines, etc.). The parachute drifts with the wind and has a forward speed of about 6 MPH, which can be directed with or against the wind using the built-in steering vents in the rear. The canopy may be turned by pulling down on the steering line rings or webbing toggles, located on the rear of the risers, just above your head. An 8-12 inch pull will produce a slow rotation, but excessive pulling will not improve the performance.

HOW TO LAND

Like birds and smart pilots, you want to reduce your landing speed by facing into the wind, or quartering slightly. Avoid all but very slight turns below 200 feet. Push your feet and knees tightly together, with your toes slightly pointed so you don't land on your heels. The tension caused by keeping your ankles and knees pressed tightly together increases their individual support, reducing your chance of injury. Keep your elbows in and try to look at the horizon, not down at the ground. This will give you a better idea of your altitude (much like looking out the side, rather than over the nose during a landing flare). Maneuver the canopy as necessary to avoid all obstacles. In event of a tree or power line landing, keep your feet together so you don't straddle a limb or wire, and be prepared to slide through and hit the ground afterwards. You should be able to avoid power lines, but if not, throw away the ripcord — it is three feet of dangling electrical conductor. To prepare for a water landing the chest strap may be unfastened (except with the Aerobatic harness) as long as you cross your arms in front of the harness to prevent falling out. Depth perception over water is difficult at best, so do not attempt to leave your harness “just above” the water.

RECOVERY

If the wind keeps your canopy inflated after touchdown, you may be dragged, so pull in on the lines closest to the ground to spill some air, and then run around the canopy to collapse it. In event of a water landing, take a deep breath just before you splash down. Once under water, unfasten your harness straps and swim as far as possible straight ahead which should be upwind, allowing the canopy will blow away from you. Entanglements with soggy nylon cloth and lines can weigh you down. If suspended from a power line, do not attempt to climb down, and do not accept assistance from anyone until the power has been shut off.

**PARA-CUSHION SERIES COMPONENT CHART
PART NUMBER 1045-()**

Component	Stock#	Seat (-1)	Back (-2)	Chair (-3)
Harness/Container:				
Back	124100		1 ea	
Seat	121100	1 ea		
Chair	124255			1 ea
Ripcords:				
2-Pin, Original	632334254	1 ea		
2-Pin, 304	632334260	1 ea		
2-pin 304 Xtra Large	632374260	1 ea		
3-Pin, Original	612394364		1 ea	
3-Pin, 303/305	612364363		1 ea	1 ea
Cap & Loop lengths:				
All Seats, 10"	861044	1 ea		
Seat w/Mil-Lopo,10.25"	861042	1 ea		
All Backs, 9"	861043		1 ea	
305 Chair, 9 "	861043			1 ea
Pilot Chutes:				
Lil' Grabber, 71E2002	790120	1 ea	1 ea	1 ea
MA-1, 53J7205	790112	1 ea	1 ea	1 ea
Bridles:				
Sewn, 40"	810150	1 ea	1 ea	1 ea
Tied, 36"	810130	1 ea	1 ea	1 ea
Canopies:				
Standard Lo-Po	420510	1 ea	1 ea	1 ea
Military Lo-Po (5)	420520	1 ea	1 ea	1 ea
Mid-Lite (6)	420550	1 ea	1ea	1ea
Lite (1014)	420601			

CAUTION

THE LITE CANOPY HAS A MAXIMUM RECOMMENDED WEIGHT LIMIT (WEARER, CLOTHES, AND EQUIPMENT) OF 175 LBS. (79.5 KG).

NOTE

Ripcord cable length is measured from the tip of the end pin to the ball swage. Pin space is measured from tip to tip.

NOTE

On new closing loops, a tolerance of minus 0 or plus 1/8 inch is allowed from the referenced flat dimensions when measured under moderate (finger) tension. Some stretching is to be expected with previously packed loops.

NOTE

Standard 2" x 3/8" parachute rubber bands were used on early production units. Later, a heavier version of the same was cut in half, rendering a 2" x 3/16" band. Current production utilizes a shorter 1 1/4" x 3/8" stow band which does not require doubling. Some units have a combination, using the smaller stow bands on the diaper and "half" line stows.

GENERAL ASSEMBLY INSTRUCTIONS

INTRODUCTION

Virtually all Para-Cushions are assembled and packed before they leave the factory, but the rigger may have to replace worn or damaged components. Specific assembly instructions that are unique to each model are immediately after these general instructions.

COMPONENTS

Compare the components of the assembly to be packed with the parts list above. Carefully inspect each item to assure an airworthy condition. Replace worn stow bands as necessary. We recommend the inspection procedure in Chapter 9 of The Parachute Manual by Dan Poynter.

PILOT CHUTE CAP

The Para Cushion models 303 (back), 304 (seat) and 305 (chair) have caps with spandex rims and a separate closing loop. All older models have caps with webbing rims and an integrated closing loop. For the spandex rim version, center the loop assembly across the diameter of the pilot chute crown and hand tack the four corners of the tape to the edge of the pilot chute crown (Illustration G-1).

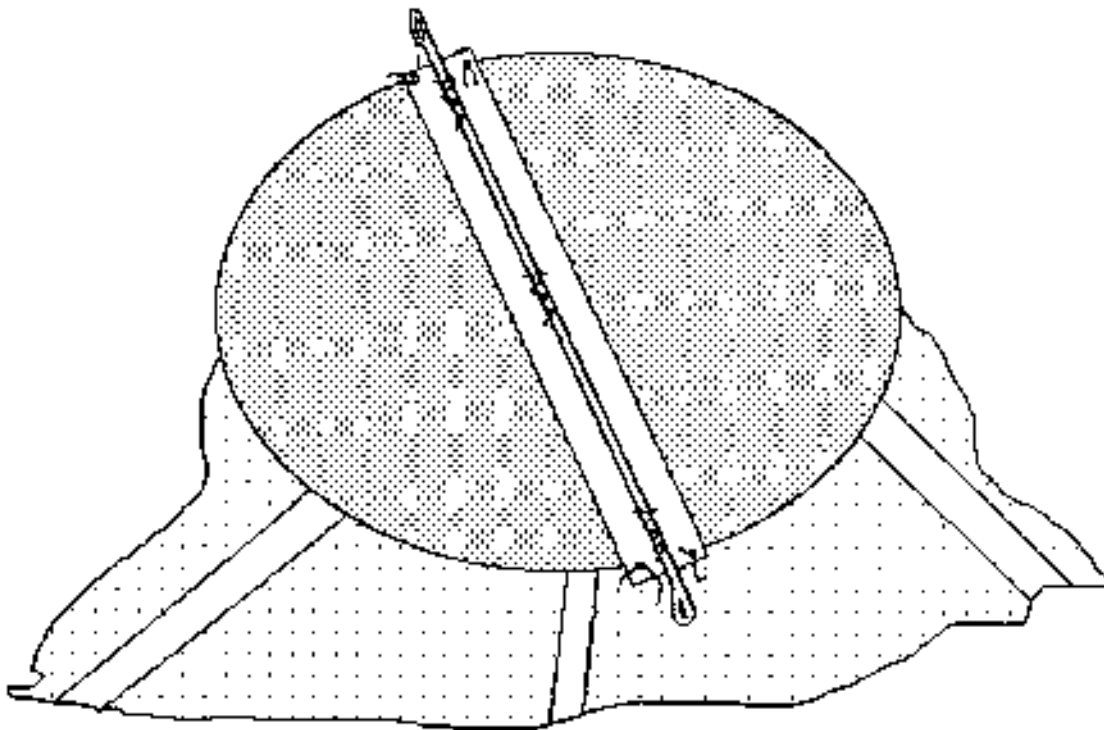
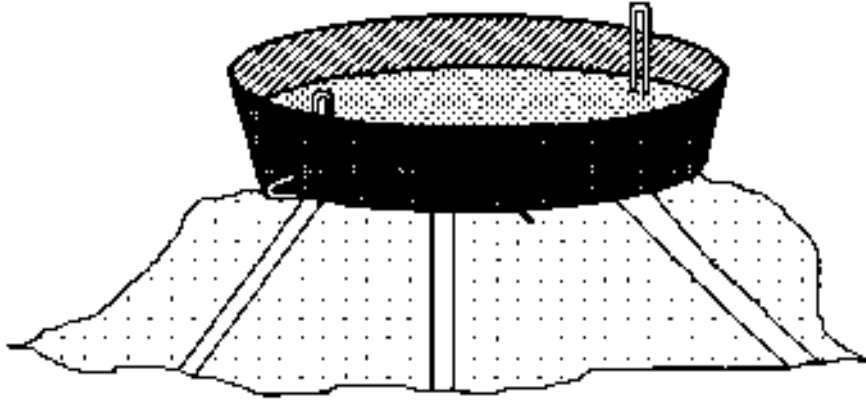

Illustration G-1

Next, route both loops through the pre-cut slots in the elastic. Fit the cap to the pilot chute top by hand tacking the cap to the edge of the crown. The hand tacking will be done in two places 90 degrees from each protruding loop using one turn of 3-cord cotton singled, or the equivalent (Illustration G-2).



Hand tack opposite sides 90° from loops.
Illustration G-2

The webbing rim (old version) of the cap is sewn directly to the crown of the pilot chute. When sewing by hand use an overthrow stitch and E-thread nylon doubled, or equivalent. When sewing by machine use E-thread nylon.

NOTE

Some stretch is to be expected with age, but ensure that the pilot chute is snug against the container when packed to prevent the spring from shifting.

WARNING

**NEVER SUBSTITUTE ANY OTHER CLOSING LOOP
FOR THE LENGTH SPECIFIED IN THE PARTS LIST
ABOVE**

BRIDLE

Attach the pilot chute to the apex of the canopy with the bridle. Both the 36-inch knotted and the pre-sewn 40-inch “loop-on” bridles are acceptable. If the knotted version is used, both bowline knots must be secured with a surgeon’s knot and locking knot using 3-cord cotton or equivalent, doubled and waxed. Trim the loose ends, leaving a 1/2-inch (approx.) tail. If the sewn bridle is used, hand tacking is not required.

ATTACHING THE CANOPY

Lay the canopy out with name plate gore and steering vents up with the harness and container in the face down, head toward canopy position. Attach the canopy so that the steering

vents will be to the rear of the wearer when the canopy is in flight. Line sequence, when viewed from the harness end, must be 12-1, 24-13, except for the Lite canopy, which with only 22 lines, must be 11-1, 22-12.

WARNING

ENSURE THAT ALL CONNECTOR LINKS ARE ASSEMBLED WITH SCREWS PROPERLY TIGHTENED.

INSTALLING THE TOGGLES

Thread the steering line through the grommet in the toggle, starting from the underside of the toggle (the side with velcro). Lay the toggle on the riser where it will be when set, and measure where the steering line should be tied. There should be one or two inches of slack in the steering line after the rest of the lines are pulled tight. Figure-8 the line through the grommet (Illustration G-3) and secure with an overhand knot. If the steering line is thin, as in the Mid-Lite, or Lite, a second figure-8 may be necessary to fill up the grommet hole. Mate the velcro to secure the toggle to the riser.

For original Para-Cushions (old style) that utilize a metal ring, route the steering lines through the guide ring on each riser, zig-zag stitch a 1 1/2 inch loop (trim the excess line), then slip loop through and over a 1 inch ring or through the steering loop. Safety tie each steering ring to the riser immediately below the guide ring using seal thread (cotton 24/4), one turn, single ply.



Illustration G-3

GENERAL PACKING INSTRUCTIONS

These general packing instructions address canopy folding and closing the diaper. (Reference can be made to The Parachute Manual, Chapter 9.) Specific instructions for line stowage, canopy folding, and container closing, follow in individual sections for each Para-Cushion type. All directional references (left, right, etc.) are from the wearer's point of view.

TOOL COUNT

Be sure you know which packing tools you begin with to ensure you don't leave any in the packed parachute.

- 1 ea Fid or packing paddle
- 1 ea Pilot chute closing strap
- 1 ea Line separator
- 4 ea Shot bags (minimum)
- 1 ea Pilot chute closing rod
- 3 ea T-handles (2 for seat)
- 3 ea Pull-up cords (2 for seat)



INSPECTION

Inspect thoroughly, checking for completeness and any damage, straighten the apex. Always perform a complete suspension line continuity check. Viewed from the harness, it should be 12-1, 24-13; except for Lite canopy which is 11-1, 22-12. Check that connector link screws are tight

PLEAT & LONG FOLD

Pleat in the normal manner, with an equal number of gores to each side. Fold the skirt up 90 degrees parallel to the radial seams (Illustration G-4).



Illustration G-4

Long fold in fifths (by folding both sides to meet at the center, and then folding in thirds, overlapping) tight and narrow (Illustration G-5).



Illustration G-5



Illustration G-6

SECURING THE DIAPER

Spread the diaper out flat. Bring the lines in the LEFT-HAND GROUP ONLY loosely up over the skirt. DO NOT tuck the lines inside the folded canopy. Tucking the lines in the canopy can cause serious burns to the canopy and lines. Wrap the diaper around the skirt and left line group (Illustration G-6)

WARNING: PUT ONLY THE LEFT HALF OF THE LINES INSIDE THE DIAPER. OTHERWISE THE PURPOSE OF THE DIAPER WILL BE DEFEATED, ALLOWING IT TO RELEASE BEFORE ALL THE LINES ARE STOWED.

Pass the three (two on older models) locking rubber bands through their respective grommets in the diaper. Secure the diaper by stowing the left line group through each of the three (or two) rubber bands, stowing from top to bottom making 1 1/2 inch bights. Unless the shorter (1 1/4") rubber bands are used, these rubber bands should be doubled to hold the line stows securely (Illustration G-7).



Illustration G-7

PARA-CUSHION BACK, AND MODEL 303

NOTE: The original Para-Cushion Back is packed the same as the 303 model EXCEPT: There are no riser covers. When a 3-stow diaper is used, doubling back the lines on the excess right line group stow will not be necessary. The accordion folds will be approximately 2 inches longer. The container flap closing sequence differs slightly, the closing sequence for the original Para-Cushion is bottom, top, right, left.

RISER PLACEMENT

Open the protective velcro flaps in the base of the container. Route the risers into the pack and place the links about one inch above the bottom of the flaps. Secure the links by attaching the hook and loop tape on the flaps (Illustration 3-1). Be careful not to snag and damage the braided suspension line on the hook tape.



Illustration 3-1

FIRST LINE STOW

Grasp both line groups together about 9" from the left link. (The slack in the right line group will be toward the link; the lines toward the canopy should be even.) Stow the first bight of line in the wearer's lower left corner of the container (Illustration 3-2).



Illustration 3-2

“EXCESS” LINE STOWS (RIGHT LINE GROUP)

The resulting “excess” length of line (about 20 inches) from the right riser will have only one half the total number of suspension lines. Stow this excess from the right line group on the right side of the container, in the upper right inboard rubber band. To do this, route the lines diagonally from the first stow to the top of the container, and place in the rubber band closest to the center of the pack tray (Illustration 3-3).



Illustration 3-3

When the 3-stow diaper is used, this bight may be doubled back on itself before being placed in the rubber band; with the 2-stow diaper, this will not be necessary. Unless the shorter (1 1/4 inch) rubber bands (See note in the parts list) are used, this rubber band should be doubled (Illustration 3-4). At this point all lines between the canopy and the container should be even and all other lines should be stowed).



Illustration 3-4

REMAINING LINE STOWS

Proceed with stowing the remainder of the lines. The next stow is in the upper left corner of the container. Continue stowing down, up, until a total of five rubber band stows are on the left side of the container. Then, routing the lines between the lower two grommets, make the next stow in the bottom right inboard rubber band in the lower right part of the container. Continue stowing on the right side of the pack, from inboard (left) to outboard (right), until all but enough line to allow for skirt placement is stowed. If, after the last stow at the top, more than 16" of line remain, a short stow may be made at the top of the container. This will be adjacent to the previous line stow, without the corresponding stow in the bottom of the container (Illustration 3-5). We recommend the use of the 1 1/4" rubber bands, but alternatively, any or all stow bands may be doubled if necessary to retain line stows securely.



Illustration 3-5

SKIRT PLACEMENT

Insert T-handles through grommets from outside of container.

The diapered skirt is placed in the wearer's upper right hand corner of the pack, with the canopy extending across the top of the container (Illustration 3-6).



Illustration 3-6

CANOPY ACCORDION FOLD

Although the diaper may be twisted slightly to reduce lumps, the canopy is stowed “flat,” not turned on edge. From the skirt, it is routed across the top of the container, then folded 90 degrees “down” the left side of the container. This fold is positioned between the side flap of the container and the central divider flap that protects the three grommets in the base of the container. Make the second fold “up” on the left side all the way to the diaper (Illustration 3-7).



Illustration 3-7

Next, the third fold is folded diagonally to the right side between the second and third grommet and then 90 degrees down to the lower right corner extending 10 inches past the bottom of the container, laying the remainder of the canopy on the right side of the container. The portion of the canopy that extends below the container is folded 90° and laid across the bottom of the container (Illustration 3-8).



Illustration 3-8

The balance of the canopy is stacked on the right side of the container (again, between the divider flaps and the side flap) using one long stow from the bottom of the container to the diapered skirt, followed by a shorter fold approximately 14 inches long (to approximate the bulk on the left side of the container). Spread the apex out flat, and route the bridle to the center of the pack (over the divider flap between the top two grommets). All folds should be fairly loose to evenly distribute the bulk of the canopy throughout the pack. There is no need to over-fill the corners (Illustration 3-9). Route the pilot chute bridle outside the pack between the top and middle grommets.



Illustration 3-9

CLOSING THE CONTAINER

The Para-Cushion Back 303 is packed without a launching disc. For ease of packing, we recommend compressing the pilot chute on a closing strap and locking with a locking rod. Pre-close the pack in the following manner by inserting the T-handles up through the grommets in the bottom of the pack tray, passing them through the grommets in the container flaps so the flaps are closed in the following closing sequence: bottom, right side, left side, top flap, spreading the inside divider flap as you go to protect the canopy from the locking loops. NOTE: The closing sequence for an Original back (NOT the 303 model) is bottom, top, right side, left side. After the T-handles are inserted, pass the pull-up cords (3) through the closing loops in the pilot chute cap and the closing loop that is attached to the left side flap. Next center the pilot chute between the upper two grommets, and pass the ends of the pull-up cords through the slots in the T-handles (Illustration 3-10).



Illustration 3-10

Holding the pilot chute in position with one hand, and with the other hand under the pack, holding it closed, turn the pack over. Draw the pull-up cords through the grommets by removing the T-handles from the pack. Draw the pull-up cords up tight until the closing loops are through the pack. (Illustration 3-11). Work from the top of the pack down inserting each ripcord pin in its loop. Slowly and carefully remove the pull-up cords to avoid friction burns on the packing loops. Remove the pilot chute locking rod and strap .



Illustration 3-11

Use a fid to tuck the excess pilot chute fabric under the rim of the cap. Dress the pack and seal the bottom pin. Complete the data card and your rigger's logbook. Be sure the ripcord handle is secure in its pocket (Illustration 3-12).



Illustration 3-12

CAUTION

**COUNT YOUR TOOLS TO ASSURE YOU HAVE
NOT LEFT ANY IN THE PACKED PARACHUTE.**

PARA-CUSHION SEAT AND MODEL 304

RISER PLACEMENT

Route the risers down the backpad and mate the velcro. This will result in the connector links being approximately four inches inside the container (Illustration 4-1). When assembling the ORIGINAL seat pack (not the 304) each steering line must be channeled through the pile velcro on the riser prior to assembly of the steering ring.

RISER TACKING

For older seats with no riser covers, tack the risers where they enter the pack with one turn of 3 cord cotton, doubled and waxed. Secure with a surgeon's knot and locking knot. Tacking is not necessary on Model 304.



Illustration 4-1



Illustration 4-2

FIRST LINE STOW

After the diaper is secured, the right line group will be 14-16" longer than the left at the pack end. Grasp both line groups together about 16" from the left link. (The slack in the right line group will be toward the link; the lines toward the canopy should be even.) Stow the first bight of line in the third rubber band on the wearer's rear left corner of the container (Illustration 4-2).

“EXCESS” OR “HALF” LINE STOWS

The resulting “excess” length (about 30”) from the right riser will have only one-half the total number of suspension lines. Holding both line groups in the front left corner of the pack, pass this “half” stow under the previous (“full”) stow, (Illustration 4-3)



Illustration 4-3

and stow in the first rubber bands, rear and front, on the left side of the center section of the pack (Illustration 4-4).



Illustration 4-4

This bight may be doubled back on itself before being placed in the rubber band to accommodate for the extra length (Illustration 4-5).



Illustration 4-5

FIRST LAYER OF LINES

Now that the lines groups are even, stow the lines in two layers. Make the stows of the first layer alternate from (wearer's) rear to front, skipping a rubber band between each stow (Illustration 4-6).



Illustration 4-6

SECOND LAYER OF LINES

Make the stows of the second layer alternate from (wearer's) rear to front, using the rubber bands that were previously skipped (Illustration 4-7).



Illustration 4-7

Place a pull up cord in both temporary locking loops. There are two located between the stow bands in the bottom of the container (Illustration 4-8).

NOTE:

The earlier models of the Para-Cushion seat model 304 had 4 locking loops, if you have 4 locking loops temporarily tie the four pull-up cords together over the lines, bringing the protector flaps up, securing the lines in place. .



Illustration 4-8

SKIRT PLACEMENT

The skirt should be even with the rear of the pack on the left side (Illustration 4-9a). The lower third of the canopy goes in the left side of the container with one S-FOLD (down, up, down (Illustration 4-9b).



Illustration 4-9a



Illustration 4-9b

CLOSE LEFT SIDE FLAP

Slip the S-folded canopy into the left side of the container. Pull up the temporary locking loops and pass them through the two middle grommets on the left flap and secure with temporary pins. Mate the velcro located at the top corner of the side flap (Illustration 4-10).



Illustration 4-10



Illustration 4-11

**ACCORDION FOLD
RIGHT SIDE**

Route the canopy across the front of the pack, below the line stows. Do not stack the folds on top of each other on the right side as is done on the left side. Turn the folds 90 degrees and stack them on their side towards the center of the container filling in the corners as you go. Spread the apex out flat and lay it on top of the folds routing the bridle to the center of the pack, then outside between the container flaps (Illustration 4-11).

Pass the pull up cords through the two middle grommets on the right flap and secure with temporary pins. (Illustration 4-12)



Illustration 4-12

CLOSING THE CONTAINER

The Para-Cushion Seat 304 is packed without a launching disc. For ease of packing, we recommend compressing the pilot chute on a closing strap and locking it with a locking rod. Pre-close the pack in the following manner by inserting the T-handles up through the grommets in the bottom of the pack tray, passing them through the grommets in the flaps so the flaps are closed in the following closing sequence: right side, left side, top and bottom flaps keeping the lines together away from the canopy. (Illustration 4-13). After the T-handles are inserted, pass the two pull-up cords through the closing loops in the pilot chute cap. Next center the pilot chute between the grommets and pass the ends of the pull-up cords through the slots in the T-handles.



Illustration 4-13

Holding the pilot chute in position with one hand, and with the other hand under the pack holding it closed, turn the pack over.

Draw the pull-up cords through the grommets by removing the T-handles from the pack. Draw the pull-up cords up tight until the closing loops are through the pack. Work from the rear of the pack to the front inserting each ripcord pin in its loop. Slowly and carefully remove the pull-up cords to avoid friction burns on the packing loops. Remove the pilot chute locking rod and strap, the four pull-up cords, and the two temporary locking pins (Illustration 4-13).

Use a fid to tuck the excess pilot chute fabric under the rim of the cap. Dress the pack and seal the end pin. Complete the data card and your rigger's logbook. Be sure the ripcord handle is secure in its pocket



Illustration 4-14

CAUTION

COUNT YOUR TOOLS TO ASSURE YOU HAVE NOT LEFT ANY IN THE PACKED PARACHUTE.

PARA-CUSHION CHAIR 305

RISER PLACEMENT

Open the protective velcro flaps in the base of the container. Route the risers into the pack and place the links one inch above the bottom of the flaps. Secure the links by attaching the hook and loop tape on the flaps. Make sure the hook tape does not snag and damage the braided suspension line (Illustration 5-1).



Illustration 5-2



Illustration 5-1

FIRST LINE STOW

Grasp both line groups together about 9 inches from the left link. (The slack in the right line group will be toward the link; the lines toward the canopy should be even.) Stow the first bight of line in the wears' lower left corner of the container (Illustration 5-2).

“EXCESS” LINE STOWS (RIGHT LINE GROUP)

The resulting “excess” length of line (about 20 inches) from the right riser will have only one half the total number of suspension lines. Stow this excess from the right line group on the right side of the container, in the upper right inboard rubber band. To do this, route the lines diagonally from the first stow to the top of the container, and place in the rubber band closest to the center of the pack tray (Illustration 5-3).



Illustration 5-3

When the 3-stow diaper is used, this bight may be doubled back on itself (Illustration 5-4) before being placed in the rubber band; with the 2-stow diaper, this will not be necessary. Unless the shorter (1 1/4 inch) rubber bands (See note in the parts list) are used, this rubber band should be doubled. At this point all lines between the canopy and the container should be even and all other lines should be stowed.



Illustration 5-4

REMAINING LINE STOWS

Proceed with stowing the remainder of the lines. The next stow is in the upper left corner of the container. Continue stowing down, up, until a total of five rubber band stows are on the left side of the container. Then, routing the lines between the lower two grommets, make the next stow in the bottom right inboard rubber band in the lower right part of the container. Continue stowing on the right side of the pack, from inboard (left) to outboard (right), until all but enough line to allow for skirt placement is stowed (Illustration 5-5). If, after the last stow at the top more than 16 inches of line remain, a short stow may be made at the top of the container. This will be adjacent to the previous line stow, without the corresponding stow in the bottom of the container.



Illustration 5-5

SKIRT PLACEMENT

The diapered skirt is placed in the wearer's upper right hand corner of the pack, with the canopy extending across the top of the container (Illustration 5-6).



Illustration 5-6

CANOPY ACCORDION FOLD

Although the diaper may be twisted slightly to reduce lumps, the canopy is stowed flat, not turned on edge. From the skirt, it is routed across the top of the container, then folded 90 degrees “down” the left side of the container, then back up laying the top fold on top of the bottom fold. This fold is positioned between the side flap of the container and the central divider flap that protects the two grommets located in the base of the container. “Size” the bottom part of the fold by laying it on top of the pocket.(Illustration 5-7).



Illustration 5-7



Illustration 5-8

Next, the canopy is folded diagonally from the wearers left shoulder down between the second and third grommet, to the bottom of the container.(Illustration 5-8).

Make one long stow from the bottom of the container to the diapered skirt, followed by a shorter fold. Spread the apex out flat, and route the bridle to the center of the pack (over the divider flap between the top two grommets). All folds should be fairly loose to evenly distribute the bulk of the canopy throughout the pack (Illustration 5-9).



Illustration 5-9

CLOSING THE CONTAINER

The Para-Cushion Chair 305 is packed without a launching disc. For ease of packing, we recommend compressing the pilot chute on a closing strap and locking with a locking rod. Pre-close the pack in the following manner by inserting the T-handles up through the grommets in the bottom of the pack tray, passing them through the grommets in the flaps so the flaps are closed in the following closing sequence: bottom, right side, left side, top flap, spreading the inside divider-flap as you go to protect the canopy from the locking loops. Route the pilot chute bridle outside the pack between the top and middle grommets. After the T-handles are inserted, pass the three pull-up cords through the closing loops in the pilot chute cap and the closing loop that is attached to the left side flap. Next center the pilot chute between the upper two grommets, and pass the ends of the pull-up cords through the slots in the T-handles (Illustration 5-10).



Illustration 5-10

Hold the pilot chute in position with one hand, and with the other hand under the pack holding it closed, turn the pack over (Illustration 5-11).



Illustration 5-11



Illustration 5-12

Draw the pull-up cords through the grommets by removing the T-handles from the pack. Draw the pull-up cords up tight until the closing loops are through the pack. Work from the top of the pack down inserting each ripcord pin in its loop. Slowly and carefully remove the pull-up cords to avoid friction burns on the closing loops (Illustration 5-12).

Remove the pilot chute locking rod and strap. Use a fid to tuck the excess pilot chute fabric under the rim of the cap. Dress the pack and seal the bottom pin. Complete the data card and your rigger's logbook. Be sure the ripcord handle is secure in its pocket (Illustration 5-13).



Illustration 5-13

CAUTION

COUNT YOUR TOOLS TO ASSURE YOU HAVE NOT LEFT ANY IN THE PACKED PARACHUTE.

REPAIR GUIDELINES

The following repair specification is set forth to aid riggers in the maintenance of Strong Parachutes. Repairs must be made only by appropriately rated FAA certified parachute riggers or lofts.

CANOPY

TYPE OF REPAIR	LIMITATIONS
Restitching	No limit as to length or number.
Patch, single side	Size limit: 50% of panel area. Limit of 3 per panel, 15 per canopy.
Panel replacement	Limit 9 per canopy
Radial Seams	Size limit: 12", no more than 4 per canopy.
Lateral bands	Damage: size limit 2"
Upper	Limit: 1 per canopy
Lower	Limit 4 per canopy
“V” tabs	No limit
Suspension Lines	No Limit

PILOT CHUTE

Same as set forth for canopies

BRIDLES

Damaged bridles should be replaced

CONTAINER

Standard military single side patches or replacement of the damaged area is authorized.

HARNESS

Any portion of the harness which is structurally damaged should be replaced in a manner to duplicate the original equipment.

RIPCORDS

Damaged ripcords should be replaced

DATA CARD

Data cards should not be discarded or replaced. When filled, they should be attached to the new card so that a complete log of packing, repairs, and alterations is recored. This is the history of the parachute.

NOTE

Darning and ripstop tape are not authorized for certified canopies as they may weaken the fabric. Single side patches are recommended for even small damaged areas.

CANOPY SPECIFICATIONS CHART

CANOPY	MIL. LOPO	REG.. LOPO	MID-LITE	LITE
Diameter	26 ft	26 ft	26 ft	26 ft
Canopy weight lbs/kg	7.75 /3.50	7.5/3.40	7.4/3.35	7.3/3.30
Max weight (lbs/kg) (total suspended weight)	254/115	254/115	254/115	175/80
Max deployment speed (kts)	150	150	150	130
No. of gores	24	24	24	22
No. of panels per gores	4	4	4	3
Suspension line strength lbs/kN	650/2.9	650/2.9	400/1.78	400/1.78
Radial tape strength lbs/kN	250/1.11	250/1.11	200/0.89	200/0.89
Canopy Cloth	Ripstop Nylon	Ripstop Nylon	Ripstop Nylon	Ripstop Nylon
Canopy Cloth porosity (CFM)	30-50	30-50	30-50	30-50
Suspension line material	Braided Nylon	Braided Nylon	Braided Nylon	Braided Nylon
No Circ. reinforcing tapes	3	1	1	1
Turn speed 360 degrees	6-8 sec	6-8 sec	6-8 sec	5-7 sec
Forward Speed (MPH/km/h)	6-8/10-12	6-8/10-12	6-8/10-12	8-10/12-16
Opening time (varies w/ speed)	1.1-2.5 sec	1.1-2.5 sec	1.1-2.5 sec	1.1-2.5 sec
TSO Category	C-23c Cat.B	C-23c Cat.B	C-23c Cat.B	C-23b
Rate of Descent fps/mps w/225 lbs/100 kg (Lite w/175 lbs/80 kg)	18.6/5.7	18.6/5.7	18.6/5.7	19.6/6.0

Mr. Edward Strong
 President, Strong Enterprises
 A Division of S.E. Inc.
 11700 Sidelight Boulevard
 Orlando, FL 32817



Department
 of Transportation
 Federal Aviation
 Administration

Dear Mr. Strong:

This is in response to your March 2, 1992, and subsequent
 submissions regarding Federal Airworthiness Certification
 authorization to identify Para-Cushion Series, Part No. 1645-1,
 emergency parachute assemblies, in accordance with the
 requirements of Federal Aviation Regulations (FAR) Part 21,
 Subpart G, Technical Standard Order (TSO) 119, and SAC
 Aeronautical Standard 25-25, Part 1, Category II.

We find your March 3, 1992, Statement of Conformity submitted
 with your request and your Quality Control Manual, dated
 December 6, 1992, acceptable.

The following data as submitted by your letter will be retained
 on file for this authorization:

- a. Strong Enterprises Form 1000, dated March 9, 1992.
- b. Strong Enterprises Form 1000, for the Para-Cushion Series
 P/C 1645-1, submitted with your March 2, 1992, request.
- c. Strong Enterprises Form 1000, for which the above
 limitations and instructions and was submitted on May 3, 1992.

Effective this date, you are authorized to identify the Para-
 Cushion Series, Part No. 1645-1, emergency assemblies with the
 appropriate TSO markings required by the applicable TSO and FAR
 21.607(d).

This authorization is not transferable to another person or
 location and is effective until surrendered, withdrawn, or
 otherwise terminated by the Administration.

Your responsibilities as a holder of a TSO authorization are
 outlined in FAR 21.6 and FAR 21, Subpart G.

The Airframe Engineer for this unit is located in Tandy Technical,
 telephone number (404) 941-2911. The Technical Support
 Specialist in charge is Jack, telephone (404) 941-2127.

Sincerely,

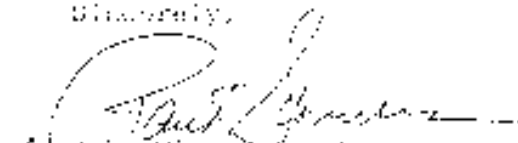
 John W. Jones
 Director, Aeronautical Branch
 Certification Office

