

!!! WARNING !!!

1. Training and/or experience are required to lower the risk of serious bodily injury or death.

NEVER use this equipment unless you have:

A. Read the warning label and completed a “controlled program of instruction” in the use of this parachute assembly

--OR--

B. Read the warning label and all appropriate owners/flight manuals and completed at least 100 ram air parachute jumps.

2. Lower the risk of death, serious injury, canopy damage and hard openings by NEVER exceeding the limits shown on the warning label.

Warning labels may be found in the following locations:

***Ram-Air Parachute* – center cell, top skin at trailing edge.**

***Circular Reserve Canopy* – next to nomenclature stamp.**

***Harness/Container System* – on back pad.**

REFLEX II™ Owner's Manual

Third Edition, February 2002

Copyright 2001

DISCLAIMER – NO WARRANTY

Because of the unavoidable danger associated with the use of the harness/container assembly, the manufacturer makes NO WARRANTY, either expressed or implied. The harness/container assembly is sold with all faults and without any warranty of fitness or purpose. Manufacturer also disclaims any liability of damages, direct or consequential, including personal injuries resulting from a defect in design, material or workmanship. By using this harness/container assembly, or allowing it to be used by others, the buyer WAIVES any liability of the manufacturer for personal injuries or other damages arising from such use.

If the buyer decides not to waive liability on the part of the manufacturer, s/he may obtain a full refund on the purchase price by returning the harness/container assembly, before it is used, to the manufacturer within 15 days of the date of the original purchase with a letter stating why it was returned.

WARNING

Sport Parachuting is a hazardous activity that can result in **serious injury** or **death**.

Parachutes sometimes malfunction, even when they are properly designed, built, assembled, packed, maintained and used. The results of such malfunctions are sometimes **serious injury** or **death**.

The FAI/IPC Technical and Safety Subcommittee Congress research estimates that worldwide 245,162 jumpers made 4,848,025 jumps in 1992. 74 fatalities resulted that year, meaning the probability of dying on a skydive is approximately 1 in 64,091. It also seems that the more experienced a skydiver is, the less likely s/he is to be killed while jumping.

Experts estimate that hundreds of people are also injured. Some of these deaths and injuries are the result of equipment malfunctions.

If you use your REFLEX II™, or if you allow someone to use it, you are acknowledging sport parachuting risks and accept the fact that the REFLEX II™ or its components may malfunction.

If you are not willing to accept the risks of sport parachuting, or if you aren't willing to accept the possibility that your REFLEX II™ or it's components may malfunction and perhaps cause you to become **injured** or **killed**, then you may return your REFLEX II™ for a full refund, before it has been used. Details on how to do this are printed above.

Trident Harness and Container, Inc.
24390 Aviation Ave.
Davis, CA 95616
www.bombermfg.com
info@bombermfg.com
(530) 753-2650
(530) 753-8572 FAX

TABLE OF CONTENTS

1. INTRODUCTION	6
Training Required	6
Description of the <i>REFLEX II™</i>	6
Main Parachute System	7
Reserve Parachute System	7
Harness	7
Design and Testing	7
Technical Standard Order (TSO) Certification	7
TSO C23(C)	8
TSO C23(D)	8
<i>REFLEX II™</i> Certification	8
Rigger Qualifications	8
Second Hand <i>REFLEX II™</i> Systems	8
Components	8
2. ASSEMBLING AND PACKING THE MAIN PARACHUTE	10
Introduction	10
Assembly	10
Pull-Out Pilot Chute	16
3. USER INFORMATION	18
4. DEPLOYMENT	19
Main Deployment	19
Jettisoning the Main Parachute	19
Reserve Deployment	19
5. RIGGER INFORMATION	20
Tools Required	20
Deployment Type	20
Limits of Damage and Webbing Wear	20
Orange Warning Label Placard Data	20
Industry Weight/Deployment Speed Limitations	20
The CATAPULT™ Horseshoe Malfunction Extraction System	21

6. RESERVE PACKING INSTRUCTIONS	22
Tools Required	22
Components	22
Reserve Packing Procedures	23
7. CYPRES INSTALLATION	31
Cypres Installation Procedure	31
8. RESERVE STATIC LINE LANYARD SYSTEM	32
Concept	32
RSL Installation Procedure	32

1. INTRODUCTION

Congratulations on the purchase of your *REFLEX II™* harness container system! Our goal is to provide you with a quality system backed by the best possible customer service that consistently meets your requirements.

Training Required

If you've never jumped a *REFLEX II™* before, or if you're transitioning from other types of gear, be sure to receive instruction on its use from a certified instructor. This introduction should consist of a practice session in a suspended harness or on the ground where you practice both routine and emergency procedures.

This manual is not a course on how to make a parachute jump. Nor does it contain the various regulations that govern sport parachuting and related activities.

It is the responsibility of the owner to ensure his/her *REFLEX II™* is properly assembled, maintained, packed, worn and used. It is also his/her responsibility to seek out and obtain proper training before s/he uses it.

The person who inspects and packs both the main and reserve parachutes must be qualified to do so.

The owner of a *REFLEX II™* should not loan it to another person without first determining that the person is fully capable of using it properly and safely.

Finally, nothing in this manual is meant to discourage the reader from using the *REFLEX II™* in a reasonable way.

The information and specifications in this manual were in effect at the time of printing.

However, we reserve the right to change the *REFLEX II™* at any time without notice and without incurring any obligation.

Description of the REFLEX II™

The *REFLEX II™* is a modern, state of the art parachute harness/container system employing not only state of the art reserve deployment technology, but also the use of advanced aerospace composite materials in its design and construction. In addition to these features, only the finest quality construction and materials available in the industry are used in the *REFLEX II™* harness/container system.

The unique single pin externally mounted reserve pilot chute provides a clean, quick and easy launch, even under the most adverse conditions. Another standard benefit of this single pin design is its fully protected reserve ripcord pin.

A new and innovative feature called *CATAPULT™* has been developed for the reserve deployment system. This feature is intended to greatly increase the odds of a reserve deployment in the event of a "horseshoe" type malfunction of the primary reserve pilot chute. However, it is not a guarantee, in any way, that the reserve will deploy correctly. More on the *CATAPULT™* system can be found in the rigger information section of this manual.

Main Parachute System

The main parachute system of your custom *REFLEX II™* was built for either a hand deploy BOC or Leg Strap (standard harness only) or Pull-Out deployment. Refer to the applicable section pertaining to your deployment system.

The main canopy may be jettisoned from the harness by it's 3-Ring release system, used under a license agreement with the Relative Workshop, Inc..

Reserve Parachute System

The reserve container will accept only ram-air reserve canopies. The *REFLEX II™* is supplied with the unique "MOLAR-BAG", a free-bag which features zero thickness where the closing loop passes through it, eliminating the need for any pull-up cord when packing the canopy into it. This also prevents any of the fabric from coming into contact with the closing loop. All *REFLEX II™* systems are manufactured CYPRES ready.

Harness

The Harness is available in both articulated (ring system) and standard designs and is custom fit to the wearer.

WARNING

A harness that is either too small or too large for the jumper's body size can affect safety and comfort during a parachute jump. If you are in question as to whether your harness fits properly, consult the Manufacturer or an FAA Master Rigger

Design and Testing

Design and testing of the *REFLEX II™* was accomplished over a period of eighteen months, and has resulted in one of the most ***rigger friendly*** systems on the market. There is no additional sewing or tacking required to assemble the *REFLEX II™* with canopies, and no special techniques are necessary to pack it. An FAA certified rigger with current skills should be able to assemble and pack the *REFLEX II™* by following the instructions in this manual.

We hope you will enjoy many years of trouble free skydiving with the purchase of your *REFLEX II™*. However, you must first fully understand how to operate and maintain the system in order to achieve the full benefits of it. Please read this manual thoroughly, cover to cover, before attempting to pack or use this equipment in any way. If, after you have read this manual, you find you do not fully understand any element, please consult a qualified rigger or a qualified instructor for operational assistance. You may also contact us with any questions you may have. We will always be glad to assist in any way possible.

Technical Standard Order (TSO) Certification

At present, there are six levels of TSO certification in use. There are systems built under TSO C23(B) in either low speed or standard category. There are systems built under TSO C23(C) in either category A, B, or C. As of 6/1/94, TSO C23(D) was implemented and TSO C23(C) was superseded.

TSO C23(C)

Parachute assemblies shall be tested to minimum limits of persons 115 kg (254 lbs.) fully equipped, and up to 150 knots.

TSO C23(D)

Parachute assemblies shall be tested to minimum limits of persons 119.7 kg (264 lbs.) fully equipped, and up to 150 knots.

REFLEX II™ Certification

The *REFLEX II™* harness and container system is the first of its kind to be approved under FAA TSO C23(D). This assembly is limited to use by persons up to 124.7 kg (275 lbs.) fully equipped, and up to 150 knots.

The upper weight limit was increased during testing in order to allow heavier jumpers a certified option for a harness and container system.

Rigger Qualifications

In order to pack and maintain the *REFLEX II™* reserve system, the Senior or Master Rigger must possess a BACK rating endorsement to their certification. However, since this system is dissimilar to old-style equipment, the rigger should be checked out for this style of system prior to certifying the *REFLEX II™* for emergency use

No certificated parachute rigger may:

(e) Pack, maintain, or alter a parachute in any manner that deviates from the procedures approved by the administrator OR the manufacturer of the parachute; or

(f) Exercise the privileges of his certificate and type rating unless he understands the current manufacturer's instructions for the operation involved

ANYONE who circumvents these instructions is in violation of FAR Part 65.129 and is therefore performing an illegal procedure.

Second Hand REFLEX II™

If you obtained your *REFLEX™* or *REFLEX II™* second-hand from a private party, be sure it is airworthy before using it. Have a rigger or loft inspect it first.

If you prefer, we will inspect your second-hand product. There is a nominal charge for this service.

Components

The *REFLEX II™* comes complete with these components:

- Harness and Container
- Hand Deploy Main Pilot Chute
- Main Pilot Chute Bridle
- Main Deployment Bag
- Main Closing Loop
- Main Risers and Toggles
- *REFLEX II™* Reserve Pilot Chute and *CATAPULT™* system.
- Reserve Freebag and Bridle
- Reserve Ripcord
- Reserve Safety-Stow
- Reserve Toggles
- CYPRES Ready Container
- 3-Ring Release Handle
- Reserve Packing Data Card
- *REFLEX II™* Owners Manual

WARNING

Only the *REFLEX II*™ reserve pilot chute system may be used with the *REFLEX II*™ harness and container system. DO NOT substitute any other pilot chute.

Only the *REFLEX II*™ reserve molar freebag, bridle and *CATAPULT*™ may be used when packing a ram-air canopy into the *REFLEX II*™ harness and container system.

Once you are sure you have these components, check to be sure the containers are properly sized for your main and reserve canopies. Refer to the TSO label on the inside of the reserve pin protector flap to determine the size of the containers. Refer to the *REFLEX II*™ compatibility chart to determine what canopies will fit in your *REFLEX II*™.

Replacement components for the *REFLEX II*™ are readily available. For more information, log onto www.bombermfg.com.

U.S. Federal Aviation Administration regulations require that the reserve parachute be inspected, maintained, assembled and packed by an appropriately rated Senior or Master Parachute Rigger. Other countries may have similar regulations.

2. ASSEMBLING AND PACKING THE MAIN PARACHUTE

Introduction

The REFLEX II™ is compatible with almost every parachute in common use today as, the REFLEX II™ is available in a variety of main container sizes. Consult the manufacturer or your dealer to ensure the volume of your canopy is compatible with your REFLEX II™. Oversized or undersized canopy volumes may cause a pilot chute-in-tow to premature opening of the main container. This manual does not provide specific instructions on folding all the various main canopies on the market. That information must be obtained from the owner's manual for the respective canopy.

Assembly

Step 1 Lay out the main parachute, flake canopy. Perform line continuity check using canopy manufacturer's instructions.

Step 2 With the line check complete, attach the connector link to the risers in the correct manner (nose of the canopy on the front risers, tail on the rear risers). Make sure you have the risers installed properly Right and Left, note the RSL ring placement for verification.

Step 3 Route the steering lines through the guide rings on the rear risers.

Step 4 Route the steering lines through the grommets in the main steering toggles from the bottom and out the top. Align the mark on the line with the grommet. Fasten the line to the toggle with what is commonly called a bowline knot and secure the running end with an overhand locking knot. Make sure the toggle is secure and will not slip.

Step 5 Attach the risers to the harness making sure you have the left risers on the left and the right riser on the right (see 3-Ring Assembly Instructions).

Step 6 Next, attach the main bag to the canopy as follows (*Figure 2-1*):

- a. Route the end of the main bridle down through the grommet in the top of the bag, through the canopy attachment point (loop or ring), then back through the grommet.
- b. With the loop end through the grommet, pass the pilot chute back through the loop, then pull the knot down through the grommet and tighten the know around the canopy attachment point.

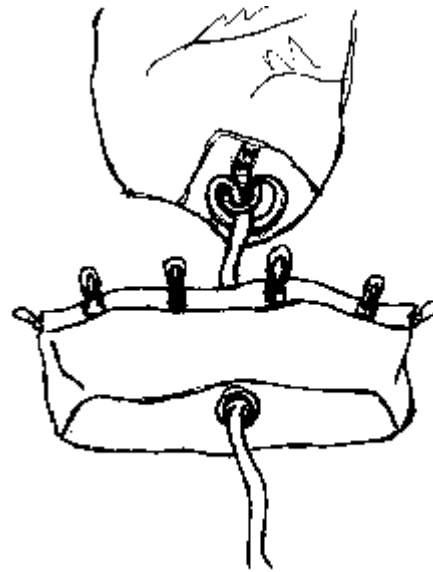

Figure 2-1

Step 7 Install rubber bands on the bag.

Step 8 Set the deployment brakes on each side by pulling the control lines down through the guide ring (*Figure 2-2*). Insert the stiffened upper portion of the toggle through the loop and pull it back up tightly against the guide ring. "S"-fold the slack between the toggle and the brake-set, and stow it in the Velcro loop provided. Then, mate the Velcro on the toggle with the Velcro on the riser (*Figure 2-3*).

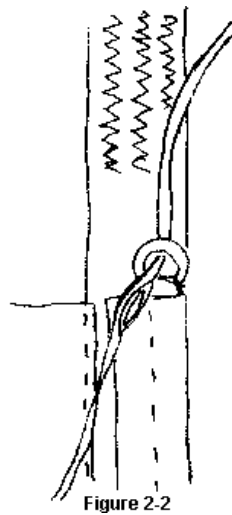

Figure 2-2



Figure 2-3

Step 9 At this point, refer to the directions provided by the canopy manufacturer for flaking and folding the canopy. After flaking and folding, the canopy should resemble *Figure 2-4* (Be sure the slider is up as far as it will go against the canopy)



Figure 2-4

Step 10 Stack the canopy in "S" folds as shown in *Figure 2-5*, keeping the slider up against the canopy and keeping the slack out of the lines. The stacked canopy should be 3-4 inches wider than the bag.

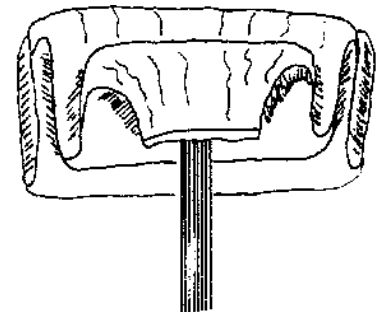

Figure 2-5

Step 11 Pull the bag down onto the canopy. Try to fill the corners and sides of the bag to distribute the bulk evenly and avoid forming a lump in the middle (*Figure 2-6*).

Step 12 Make locking stows using the suspension lines to close the mouth of the bag. There are four locking stows (*Figure 2-7*).

During this part of the packing procedure, always make sure that the rubber bands used on the locking stows are strong and in good condition. The weight of the canopy inside the bag comes to bear on these locking stows when the canopy is lifting off the jumper's back during deployment, and a broken line stow could result in an out-of-sequence deployment.

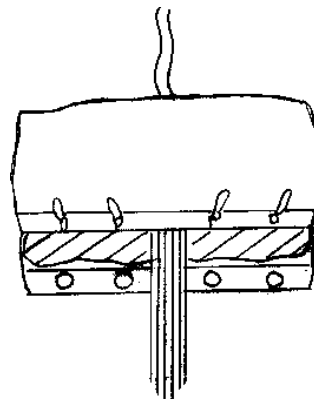

Figure 2-6

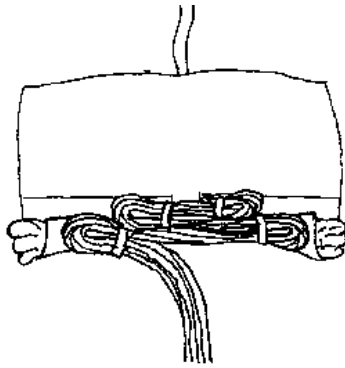

Figure 2-7

Step 13 Pull the bridle out of the top of the bag until the metal ring of the canopy is seated against the grommet of the bag. Be sure there is no canopy fabric between the ring and the grommet. Stow the lines in the locking stows. Now stow the remaining suspension lines across the bottom of the bag using the rubber bands at each end. Leave 18" to 24" of un-stowed lines between the bag and the connector links.

Step 14 Lay the risers in the "trough" between the sides of the reserve container and the riser cover, and place the connector links in the lower corners (NOT against the reserve tray – see *Figure 2-8*). Place the bag in the container with the lines stowed towards the bottom. This position is important; if the lines are stowed towards the top (towards the reserve), it may be more difficult for the pilot chute to extract the bag. (*Figure 2-9*)



Figure 2-8



Figure 2-9

NOTE:

If your *REFLEX II™* is equipped with a THROW-OUT pilot chute (Leg or BOC), continue with the next page of these instructions.

If your *REFLEX II™* is equipped with a PULL-OUT pilot chute, skip to Page 16 of these instructions.

Step 15 Thread the pull-up cord through the closing loop. The bridle should be routed to the upper right hand corner of the main container. Thread the pull-up cord through the #2 sub flap grommet and pull the loop through as shows in *Figure 2-10*.

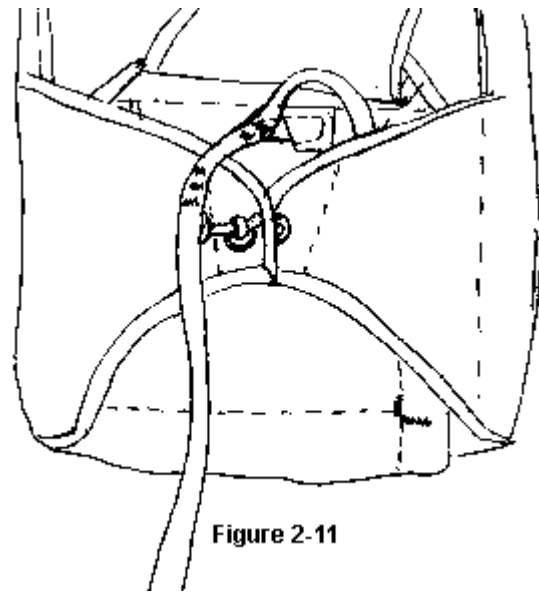

Step 16 Close the right side #3 flap, then the left side #4 flap in the same manner. Insert the curved pin through the loop and remove the pull-up cord SLOWLY to avoid damaging the loop. Attach the bridle Velcro to the tab on the sub flap. (*Figure 2-11*)



Step 17 Fold the pilot chute in half as shown in *Figure 2-12*.

Step 18 Fold back and “S” fold the bridle as shown in *Figure 2-13*.



Step 19 Fold the pilot chute in thirds as shown in *Figure 2-14*.



NOTE: If you have a leg strap throw-out pilot chute, go to **Step 23**.

Step 20 Fold pilot chute in half about its center and roll TIGHTLY in preparation to insert into the BOC pouch as shown in *Figure 2-15*.



Step 21 Stow Excess bridle under the bridle retaining flap as shown in *Figure 2-16*.

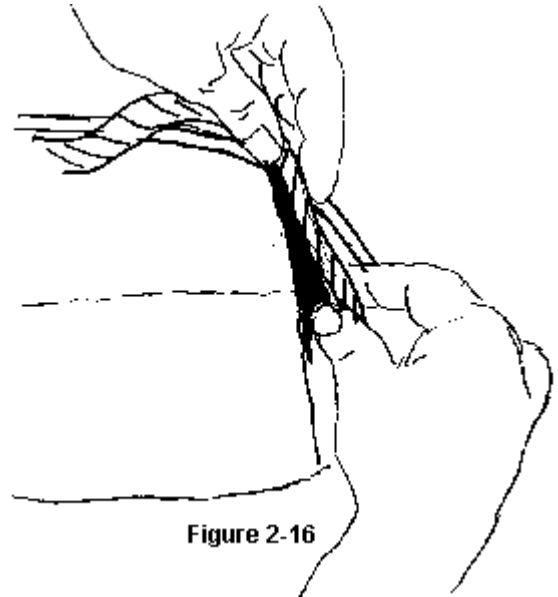

Step 22 Close pin protector flap as shown in *Figure 2-17*.

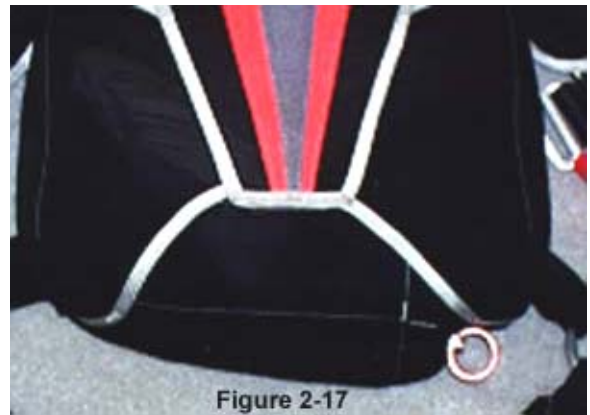

NOTE: To finish Throw-Out BOC procedures, go to Step 26.

Step 23 Mate the Velcro along the lumbar strap and container side, tucking the excess bridle under the side flap as shown in *Figure 2-18*.

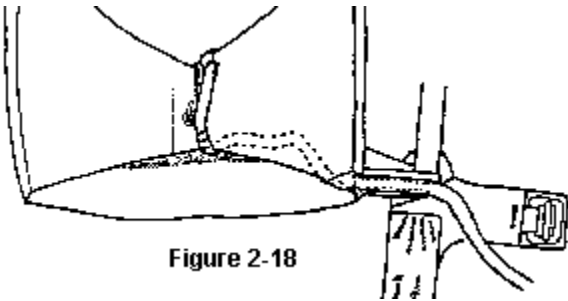

Figure 2-18

Step 24 Close the pin protector flap as shown in *Figure 2-19*.

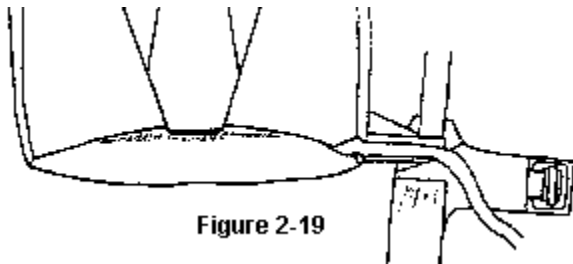

Figure 2-19

Step 25 Fold pilot chute in half about its center and roll TIGHTLY. Insert into the leg pouch as shown in *Figure 2-20*.

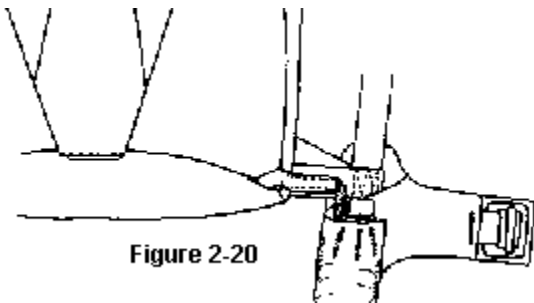

Figure 2-20

Step 26 Close the riser covers by inserting the tab on the reserve top flap into the pocket provided on the riser cover as shown in *Figure 2-21*.



Figure 2-21

Your fully assembled and packed REFLEX II™ is shown in *Figure 2-22*.

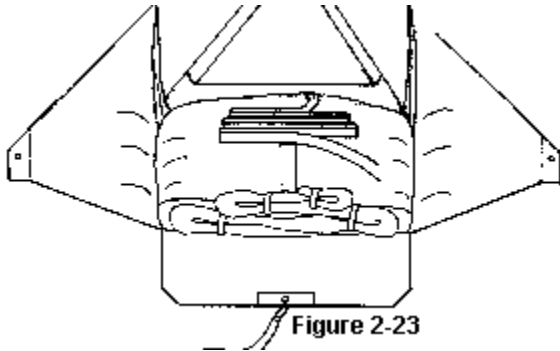

Figure 2-22

NOTE: Packing procedures are completed for Throw-Out style pilot chutes.

Pull-Out Pilot Chute

Step 27 Thread the pull-up cord through the closing loop. Arrange the bridle in folds six to eight inches long, and lay the folded bridle across the upper part of the bag as shown in *Figure 2-23*. Be sure NOT to tuck these folds down between the bag and the bottom of the reserve container. To do so may retard the pilot chute during extraction.



Step 28 Loosely fold the pilot chute and lay it across the bag as shown in *Figure 2-24*. **IMPORTANT!! THE HANDLE AND PIN MUST EXIT THE CONTAINER AT THE LOWER RIGHT CORNER.**

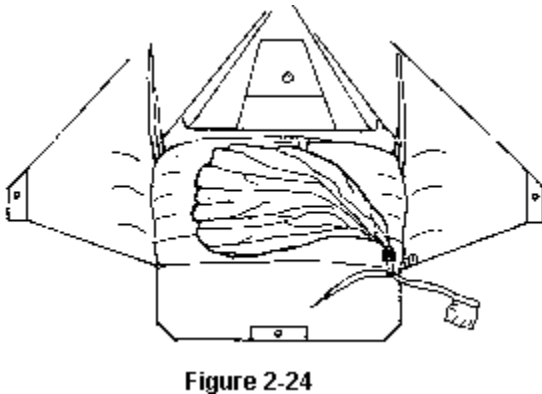

Step 29 Thread the pull-up cord through the #2 sub flap grommet and pull the loop through as shown in *Figure 2-25*.

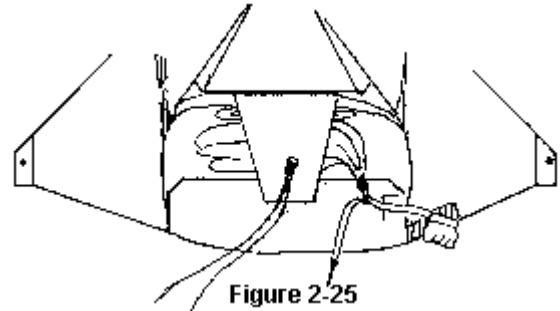

Step 30 Close the #3 right side flap, then the #4 left side flap, securing the closure pin as shown in *Figure 2-26*.

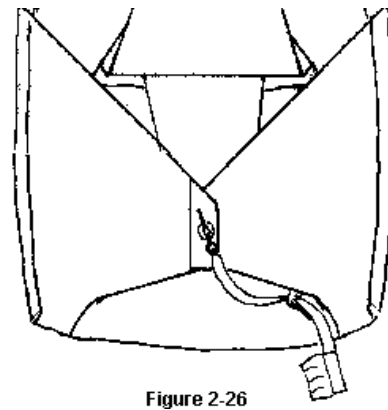

Step 31 Tuck the slack in the tape under the right side flap and mate the Velcro on the handle to the Velcro under the protective cover on the right side of the bottom flap as shown in *Figure 2-27*.

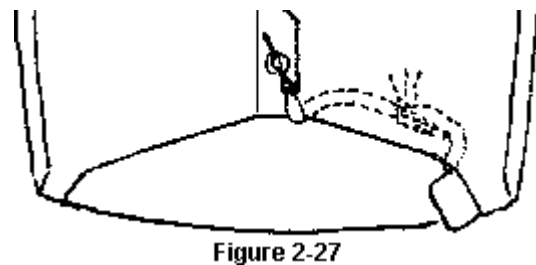

Step 32 Close the top flap protector by tucking the “shark’s tooth” underneath the flaps as shown in *Figure 2-28*.

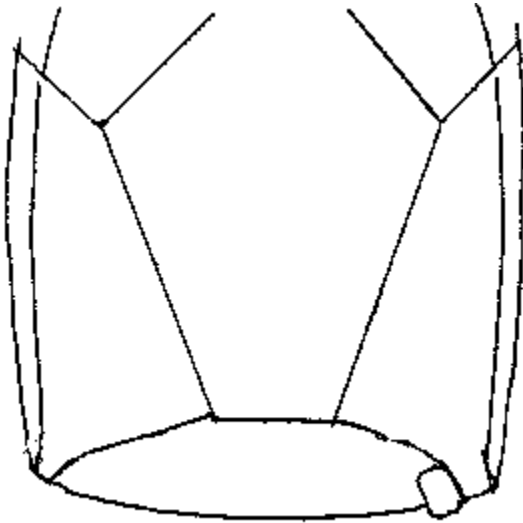

Figure 2-28

NOTE: Packing procedures are complete for Pull-Out style pilot chutes.

3. DONNING, RETENTION AND ADJUSTMENT

Step 1 Inspect Reserve ripcord for correct seating. Make sure cable is free in its housing.

Step 2 Ensure Rigger's Seal is intact and packing data card is filled out.

Step 3 Ensure 3-Ring Releases are properly assembled and RSL is hooked up.

Step 4 Verify main deployment system routing and that the main closing pin seated correctly.

Step 5 With the packed rig on your back, thread the chest strap through the buckle located on the users right side.

Step 6 Snug the chest strap down so the main lift webs run parallel down each side of your torso. Stow the excess chest strap in the elastic keeper.

Step 7 Thread both leg straps through their respective buckles and tighten them until snug. Stow the excess in the channels provided in the leg pads, pulling the elastic keepers down to hold the excess firmly in place.

End of Procedure.

4. DEPLOYMENT

Main Deployment

NOTE: When deploying the main parachute, be sure that you are flat and stable.

Step 1 Reach back to your main deployment handle and get a firm grasp on it.

Step 2 Pull the handle out to full arm extension and throw it to your right as hard as possible.

Step 3 Return to your stable freefall position.

Jettisoning the Main Canopy

Step 1 Grasp the cutaway pillow located on the right hand side of your harness.

Step 2 Unpeel the Velcro and pull sharply downward to full arm extension.

Step 3 Make sure the cables are fully extracted.

Reserve Deployment

Step 1 Grasp the reserve ripcord handle located on the left side of your harness.

Step 2 Pull the handle out of it's pocket.

Step 3 Pull down sharply on the ripcord handle making sure it is fully extracted.

End of Procedure.

5. RIGGER INFORMATION

Tools Required

- Pull-up Cord (at least 40" long)
- One (1) 'T' Bodkin
- One (1) Soft Bodkin (AAD Installation only)
- One (1) Packing Paddle
- Two (2) Velcro Flags (For covering hook Velcro during packing process)

WARNING

The use of a positive leverage device (i.e. 'T' Bars or Cranks) is expressly forbidden as they WILL cause permanent damage to the reserve operating system and cannot be used during the loop adjustment phase anyway.

Deployment Type

There are currently 5 different canopy deployment methods in common use. Of these, only TYPE 5 is approved for use in the REFLEX II™ harness and container system. The description and an example is below.

TYPE 5:

Free Bag: Canopy is stowed in bag and lines are stowed on/in the bag. Examples: Raven, Amigo

Limits of Damage and Webbing Wear

Minor scuffing is permissible if no individual fiber bundles are torn or cut. If any fiber

bundles are damaged in this manner on any load bearing webbing the rig is to be grounded and returned to the factory for evaluation and repair/replacement of the damaged part.

Orange Warning Label Placard Data

As part of the manufacturer's requirements, the ORANGE WARNING! LABEL located on the lower external back pad MUST BE filled in by the Rigger assembling and packing the REFLEX II™ (See example *Figure 5-1*) FAILURE TO DO SO WILL RESULT IN THE TSO BEING NULL AND VOID!

WARNING

- PROPER TRAINING AND/OR EXPERIENCE ARE REQUIRED TO LOWER THE RISK OF SERIOUS INJURY OR DEATH.
NEVER USE THIS EQUIPMENT UNLESS YOU HAVE:
 - READ AND UNDERSTAND THIS WARNING LABEL AND COMPLETED A "CONTROLLED PROGRAM OF INSTRUCTION" OR
 - READ AND UNDERSTAND THIS WARNING LABEL AND APPROPRIATE OWNERS FLIGHT MANUALS, PACKING INSTRUCTIONS AND COMPLETED AT LEAST 100 RAM AIR PARACHUTE JUMPS.
- LOWER THE RISK OF DEATH SERIOUS INJURY, CANOPY DAMAGE AND SEVERE HARD OPENINGS BY NEVER EXCEEDING THE LIMITS SHOWN BELOW.

	RESERVE	MAIN
MAXIMUM DEPLOYMENT SPEED	KTS	KTS
MAXIMUM GROSS WEIGHT (JUMPER + CLOTHING + EQUIPMENT)	LB.	LB.
MANUFACTURER		
CANOPY TYPE		

- REFER TO OWNERS MANUAL FOR PLACARD INFORMATION AND COMPATIBILITY LIMITATIONS
- FILL IN DATA PANEL WITH A WATERPROOF PEN
- CHANGE DATA ON LABEL IF A DIFFERENT CANOPY IS INSTALLED
- • • REMOVAL OF THIS LABEL VOIDS THE TSO • • •

Figure 5-1

Industry Weight/Deployment Speed Limitations

The data needed to fill in the Data Panel is best gained from the specific canopy manufacturer for each canopy, and can often be found on the canopy's data panel. This information will enable the Rigger to comply

with these requirements. We find that a PILOT ultra fine point permanent marker MODEL SC-UF or equivalent works best.

Please note that there may be instances where one model canopy may have TWO DIFFERENT placard limitations; one as a reserve and one as a main. An example of this is the Precision Raven 4 canopy. As a Reserve, it is limited to 254 lbs. Maximum gross weight. However, as a Main it is placarded to 288 lbs. Make sure that you, the Rigger, mark the correct space on the Data Panel for the correct canopy.

The CATAPULT™ Horseshoe Malfunction Extraction System

The CATAPULT™ System was designed and developed as a more reliable and consistent method of reserve extraction during a “Horseshoe” type malfunction of the primary reserve pilot chute. Extensive testing has shown that the CATAPULT™ secondary reserve pilot chute affords enough drag to extract and lift off the reserve deployment bag in a variety of situations. However, this does not in any way guarantee that a clean deployment will take place. Rather, it may decrease the odds of the bag remaining

in the reserve tray until there is insufficient time for an orderly deployment.

<p>NOTE: Removal of the CATAPULT™ secondary pilot chute is allowed, but not recommended. Removal should be performed by a Rigger.</p>
--

The CATAPULT™ System functions extremely well under normal operating conditions with the reserve freebag being “Turbo Boosted” from the pack tray for clean deployment of the reserve parachute.

6. RESERVE PACKING INSTRUCTIONS

Tools Required

- Pull up cord (at least 40" long)
- One (1) 'T' Bodkin
- One (1) Soft Bodkin (AAD Installation only)
- One (1) Packing Paddle
- Two (2) Velcro Flags (for covering hook Velcro during packing process)

WARNING

The use of a positive leverage device (i.e. 'T' Bars or Cranks) is expressly forbidden as they WILL cause permanent damage to the reserve operating system and cannot be used during the loop adjustment phase anyway.

WARNING

Only the *REFLEX II™* reserve pilot chute may be used with the *REFLEX II™* Harness/Container System. DO NOT substitute any other pilot chute.

Only the *REFLEX II™* reserve molar freebag, bridle and *CATAPULT™* may be used in packing a ram-air canopy into the *REFLEX II™* Harness/Container System.

Once you are sure you have these components, check to be sure the containers are sized properly for your main and reserve canopies. Refer to the TSO label on the inside of the reserve pin protector flap to determine the size of the containers. Refer to the *REFLEX II™* compatibility chart to determine what canopies will fit in your *REFLEX II™*.

Components

The *REFLEX II™* comes complete with these components:

- Harness and Container
- Hand-Deploy Main Pilot Chute
- Main Pilot Chute Bridle
- Main Deployment Bag
- Main Closing Loop
- *REFLEX II™* Reserve Pilot Chute and *CATAPULT™* System
- Reserve Molar Bag and Bridle
- Reserve Ripcord
- Reserve Through-Loop
- Reserve Toggles
- CYPRES Ready Container
- Main Risers and Toggles
- 3-Ring Release Handle
- Reserve Packing Data Card
- *REFLEX II™* Owners Manual

If you use main parachute components that were not supplied with the harness and container, be sure they have the correct dimensions and are made of the same materials. For instance, be sure the break-away cables are the proper length.

Replacement components are readily available. Log onto www.bombermfg.com for more information

U.S. Federal Aviation Administration regulations require that the reserve parachute be inspected, maintained, assembled and packed by an appropriately rated Senior or Master Parachute Rigger.

Other countries may have similar regulations.

Reserve Packing Procedure

Step 1 Ensure all necessary parts are available prior to proceeding as depicted in *Figure 6-1*.

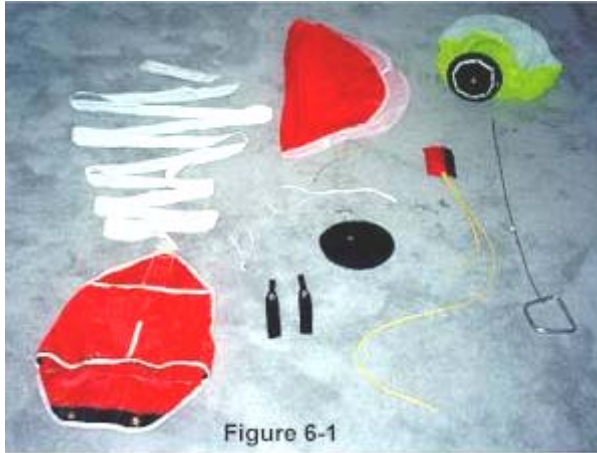

Figure 6-1

Step 2 Assemble primary reserve pilot chute using a “Lark’s Head” knot as shown in *Figures 6-2* and *6-3*.



Figure 6-2



Figure 6-3



Figure 6-4

The completed Reserve Deployment System assembly is shown in *Figure 6-5*.

Step 3 Assemble CATAPULT™ pilot chute onto bridle using a “Lark’s Head” knot as shown in *Figure 6-4*.

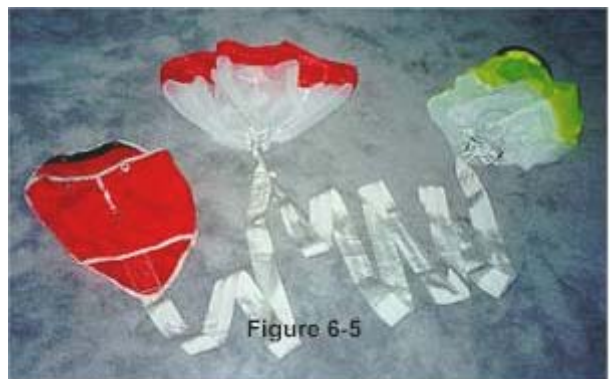
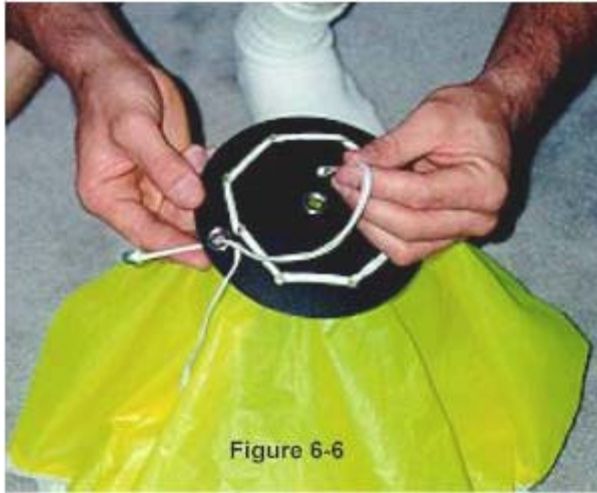
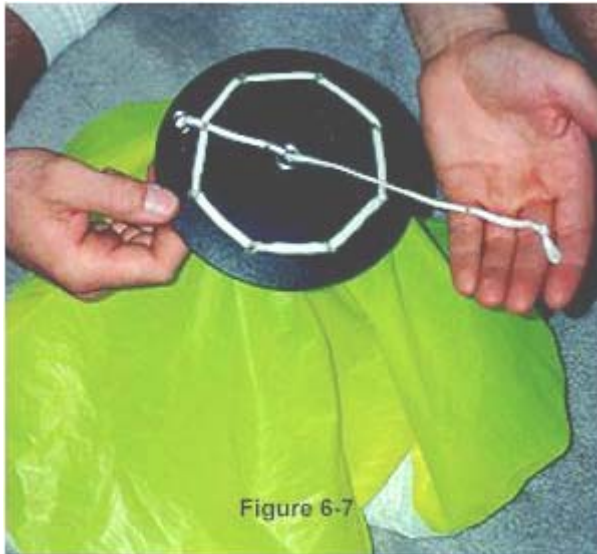

Figure 6-5

Step 4 Insert the closing loop through the outer grommet in the primary reserve pilot chute cap, as shown in *Figure 6-6*.



Step 5 Insert the closing loop down through the center grommet in the cap as shown in *Figure 6-7*.



Step 6 Insert the closing loop free end through the aperture in the outer cap as shown in *Figure 6-8*.

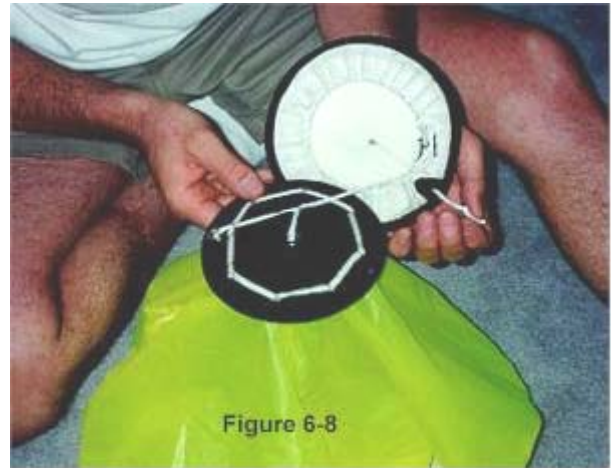

NOTE: When installing the outer pilot chute cap onto the primary reserve pilot chute, be sure to keep the free end of the closing loop directly opposite the outer grommet.



Step 7 Make sure two (2) to four (4) inches of the free end of the closing loop extends through the outer cap as shown in *Figure 6-9*. The rest of the free end of the loop should be adjusted out so as to open up the loop now inside the pilot chute.

Step 8 Set the deployment brakes and stow the excess control line as shown in *Figure 6-10*.

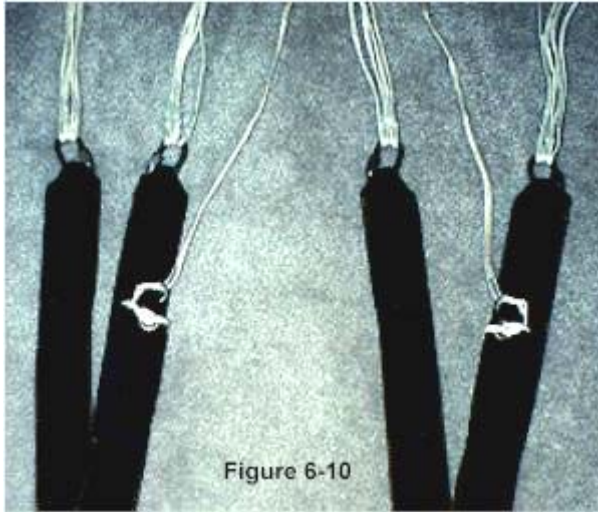

Figure 6-10

Step 9 Pack canopy according to the manufacturer's instructions. When the canopy is ready for insertion into the deployment bag, refer to *Figure 6-11*.



Figure 6-11

Step 10 'S' Fold the canopy as shown in *Figure 6-12*.



Figure 6-12

Step 11 Fold the Molar "Ears" to be inserted in the deployment bag as shown in *Figure 6-13*.

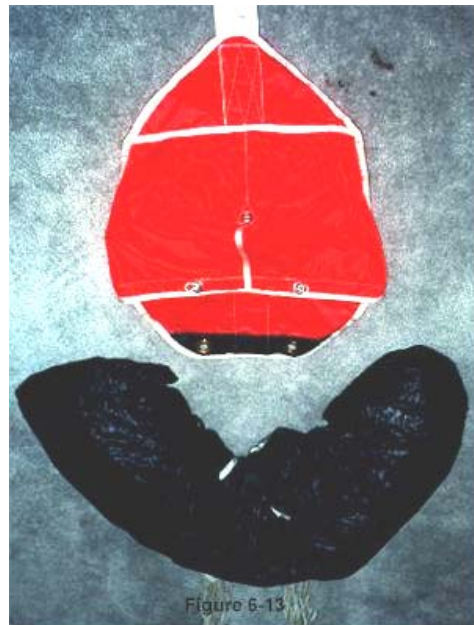
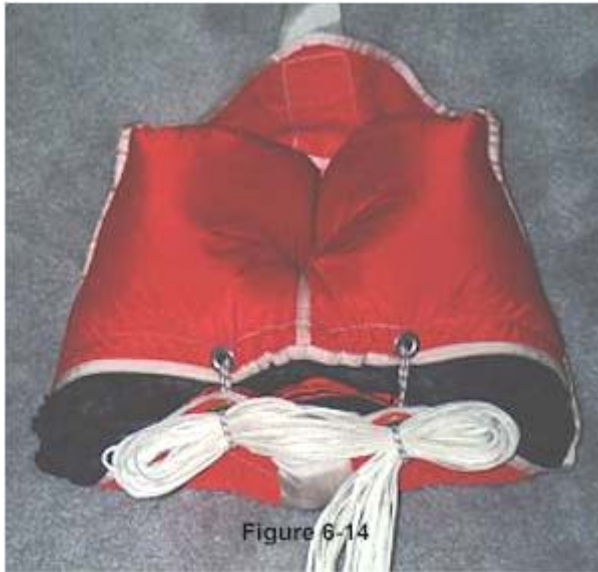

Figure 6-13

NOTE: Make sure sufficient canopy is pushed into the upper areas of the deployment bag to ensure an even sided "well" is created for the Primary Reserve Pilot Chute to sit in.

Step 12 Close the locking stows as shown in *Figure 6-14*. Make stows approximately 1 and ½ inches long.



Step 13 Stow the remaining line in the line stow pouch as shown in *Figure 6-15*.

NOTE: Make sure the hook Velcro is covered during this operation to avoid snagging the suspension lines.



Step 14 Thread the Ripcord through the housing at this time. Be sure to correctly route the RSL lanyard as shown in *Figure 6-16*. See page 31 for RSL information.

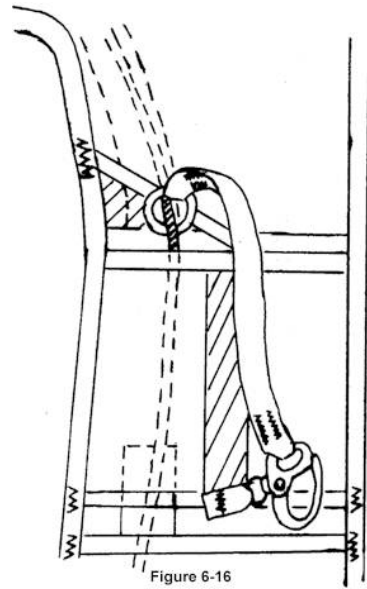

Step 15 Insert the 'T' Bodkin through the grommet in the pack tray and lay the risers in their tracks. Close the tuck tabs of the internal riser covers (*Figure 6-17*)

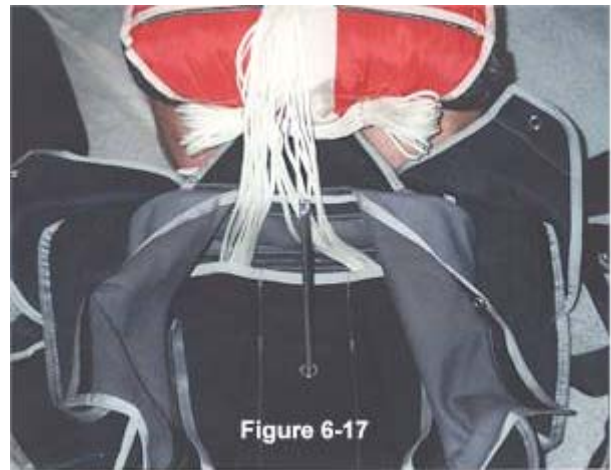

NOTE: If installing an authorized AAD use a Soft Bodkin as shown in *Figure 6-18*.

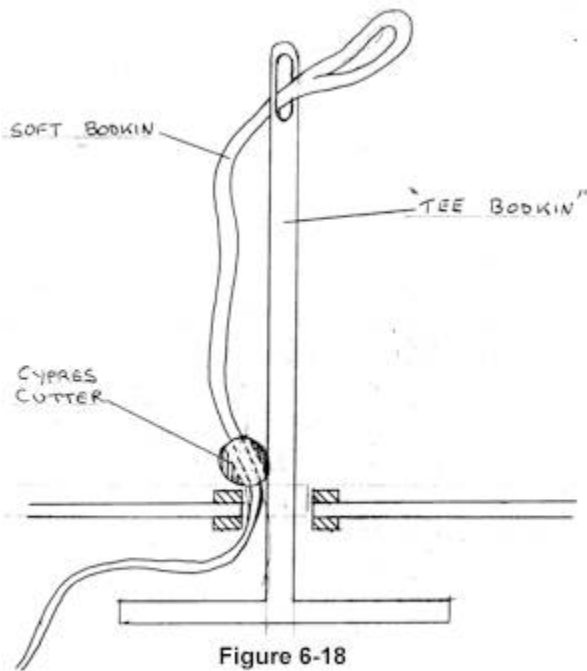

Step 16 Place the deployment bag in the pack tray, threading the 'T' Bodkin through the bag and work the bag into the lower corners.

Step 17 'S' Fold the bridle up to the *CATAPULT™* attachment point as shown in *Figure 6-19*.



Step 18 If installed, fold the *CATAPULT™* pilot chute in thirds as shown in *Figure 6-20*.



Step 19 Fold the *CATAPULT™* back towards the center in thirds as shown in *Figure 6-21*.



Step 20 Close the #1 reserve sub-flap over the CATAPULT™ pilot chute as shown in *Figure 6-22*.



Figure 6-22

Step 21 Turn the primary reserve pilot chute over and compress the spring to expose the loop. Insert a pull-up cord through the loop (*Figure 6-23*)

NOTE: Make sure a loop approximately six (6) to eight (8) inches long is showing. This will help later on. If using an AAD, be sure to use a **500 lb. Spectra** Pull-up cord.



Figure 6-23

Step 22 Close the #2 and #3 side flaps, then the #4 top flap as shown in *Figure 6-24*. Stow the excess bridle as shown, being sure to keep the folds within the #5 flap outer edges.



Figure 6-24

Step 23 Close the #5 top flap and insert the pull-up cord through the 'T' Bodkin (next to the Soft Bodkin), leaving about four (4) inches of bridle exposed. (*Figure 6-25*)



Figure 6-25

Step 24 Turn the rig over and pull the 'T' Bodkin and pull-up cord through (*Figure 6-26*). Inset the reserve ripcord pin as shown in *Figure 6-27*.

NOTE: A Temp Pin with a long flag *may* be inserted along side the reserve pin to help keep the reserve pin from being bent if too much pressure is applied during closing.

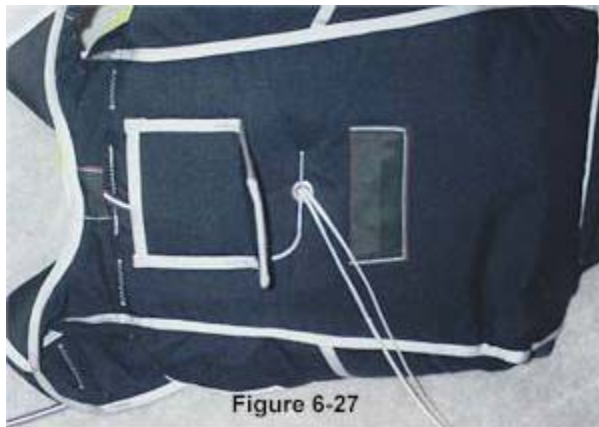

Step 25 Remove the pull-up cord and turn the rig back over.

Step 26 Center the primary reserve pilot chute and route the free end of the closing loop over the right, lower corner of the tray. Compress the pilot chute to within two (2) inches of full compression and snug it in place using the adjustable loop. (*Figure 6-28*)



Step 27 Stuff the fabric up under the hard cap between the coils of the spring. For best results, fill all the space beneath the hard cap. (*Figure 6-29*)



Step 28 Cinch the closing loop tight using a series of short, sharp jerks while applying full downward pressure on the reserve pilot chute. (*Figure 6-30*)

NOTE: It is not recommended to use a long, continuous pull on the closing loop as this may bend the pin or damage other parts of the system.



Step 29 Seat the pin to its normal position and correct alignment with the ripcord housing. Seal the pin per **FAR Part 65**.

Step 30 Insert the excess loop under the cosmetic cap as shown in *Figure 6-31*. This will allow field adjustments to be made **by the Rigger who packed it only!**



End of Procedure.

7. CYPRES INSTALLATION

The REFLEX II™ harness/container system comes equipped CYPRES ready. For installation, please follow the installation procedure.

CYPRES Installation Procedure

Step 1 Install the CYPRES processing unit in the elastic pouch provided on the reserve container vertical wall.

Step 2 Thread the control unit through the channel provided on the reserve pack tray (located under the left hand reserve riser cover.).

Step 3 Pull plenty of slack cable through the channel. Thread the control unit through the gap provided under the top hinge area of the #1 reserve sub flap. (*Figure 7-1*)

Step 4 Turn the rig over and pull open the pin door.

Step 5 Insert one or two fingers up through the aperture cut in the back pad. Push the control unit out through the back pad aperture, using your fingers as a guide.

Step 6 Insert the control unit into the clear plastic pocket located on the back pad.

Step 7 Remove all slack from the cable all the way back to the processing unit installed on the reserve wall.

Step 8 Thread the cutter through the same channel as the control unit, allowing it to exit from the access cut in the middle of the channel. Insert it into the elastic holder located on the pack tray wall.

Step 9 Remove any slack cable from the system by coiling (not folding or crimping in any way) it into the pouch provided next to the mouth opening where you inserted the processing unit.

Step 10 Double check your installation to ensure proper orientation of all CYPRES components.

End of Procedure.

8. RESERVE STATIC LINE LANYARD SYSTEM (RSL)

Concept

The basic concept of the Reserve Static Line Lanyard or RSL system is that the lanyard is attached from the left main riser to a pin with a ring through which the reserve ripcord is routed. Upon jettisoning a malfunctioning main canopy, the lanyard automatically pulls the cable, which pulls the pin of the reserve ripcord. This results in activation of the reserve with minimum loss of altitude. Through the use of the RSL, a greater degree of safety is realized. IT MUST BE STRESSED HOWEVER, THAT THE RSL IS SIMPLY A BACKUP TO MANUAL ACTIVATION OF THE RESERVE DEPLOYMENT SYSTEM AND SHOULD NEVER BE RELIED UPON. IT IS A MECHANICAL SYSTEM, AND COULD FAIL.

In the event of a malfunction, the jumper must still manually pull the ripcord even though the RSL may activate the reserve faster. There have been instances where the RSL has been disconnected and the jumper relied on the RSL for activation. They relied on it all the way to impact.

RSL Installation Procedure

The REFLEX II™ RSL System must be installed by a rigger during the packing of the reserve, since the ripcord must pass through the ring on the end of the lanyard prior to closing and sealing the reserve. The following steps MUST be followed to install the REFLEX II™ RSL System.

Step 1 The ring end of the lanyard is installed first. Mate the Velcro on the lanyard with the ring to the Velcro pathway

on the left shoulder area. Route the ripcord/cable assembly through the lower housing, and then through the ring on the lanyard (Figure 8-1). Now route the ripcord/pin assembly through the upper housing and out to the back pad area under the pin protector flap.

Step 2 Make sure the loose end of the lanyard with the snap shackle is not routed under or through any housings or hardware. Attach the shackle to the RSL ring on the left main riser. It is imperative that the lanyard has a direct route from the cable guide ring to the ring on the left riser. Failure to do so results in fatal consequences.

End of Procedure.

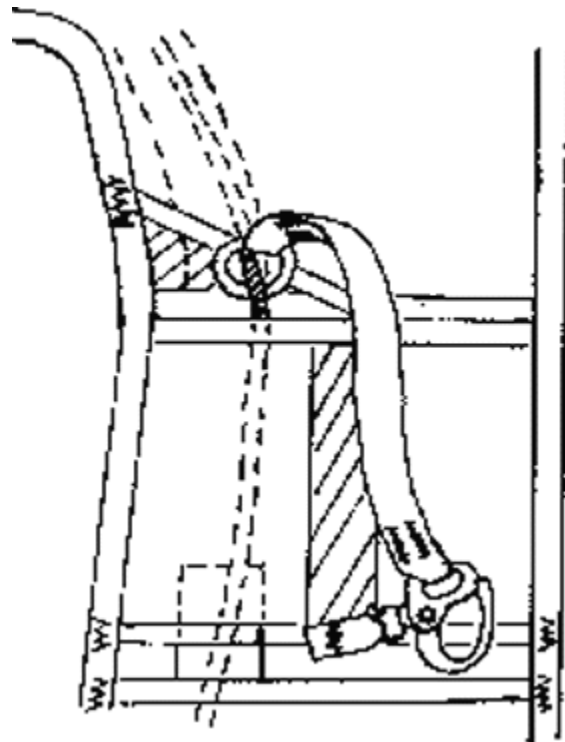

Figure 8-1