

REV	REVISIONS DETAILS	E.C.P.	DRN	APPN	DATE

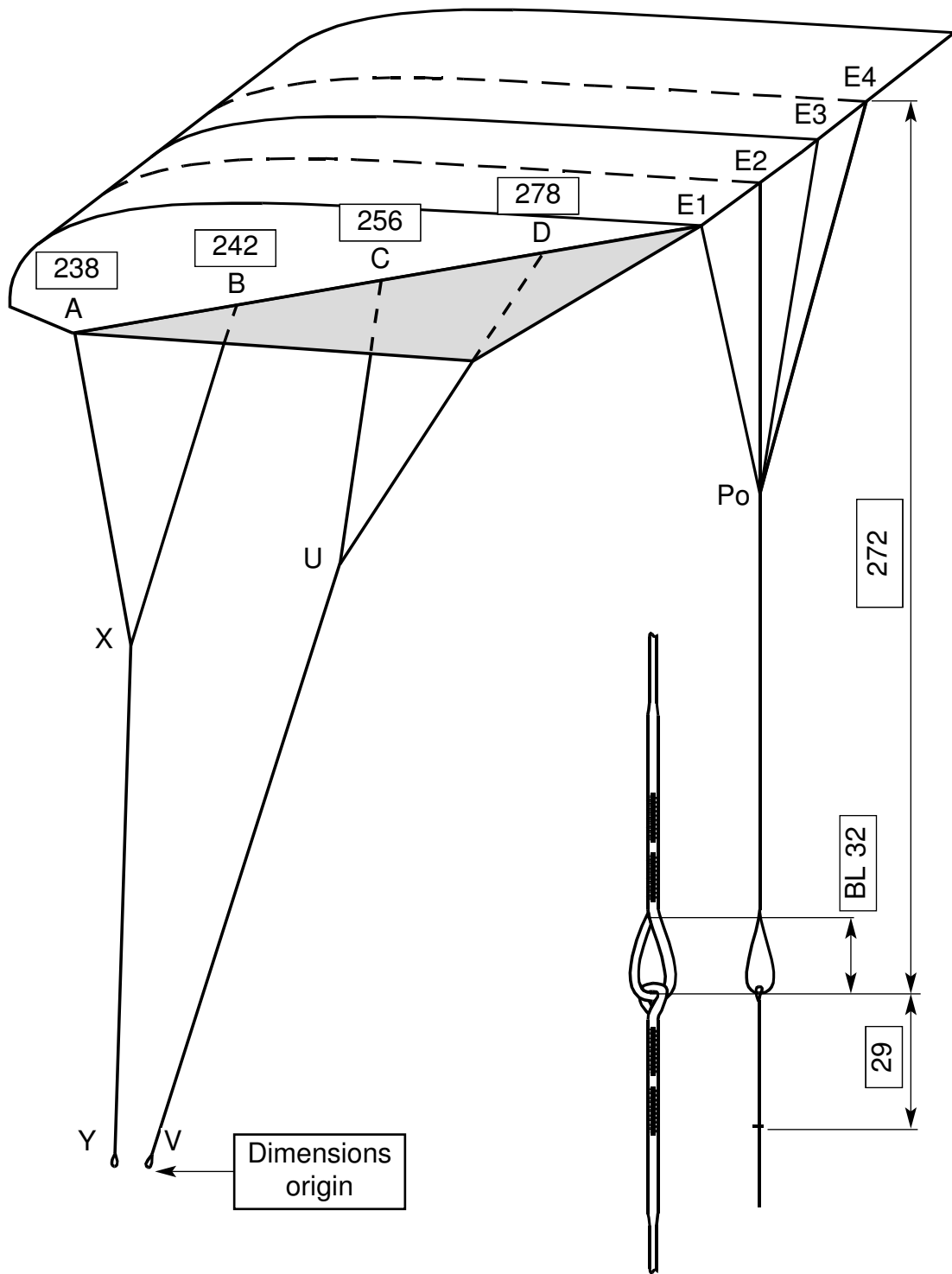

SLIDER PN: P1482-02

Drawn ADH	DATE 19/09/02	Tolerances ± 2	AERODYNE RESEARCH	
CHKD JLD	APPD AHD	DWG REV No.		
SCALE NTS	DIMENSIONS in cm			
TITLE: CANOPY RESERVE - 99 Ft² FINAL CONTROL DOCUMENTS		DWG No. P1482-01	VERSION	A4
			PAGE 3	

REV	REVISIONS DETAILS	E.C.P.	DRN	APPN	DATE

AIRFOIL

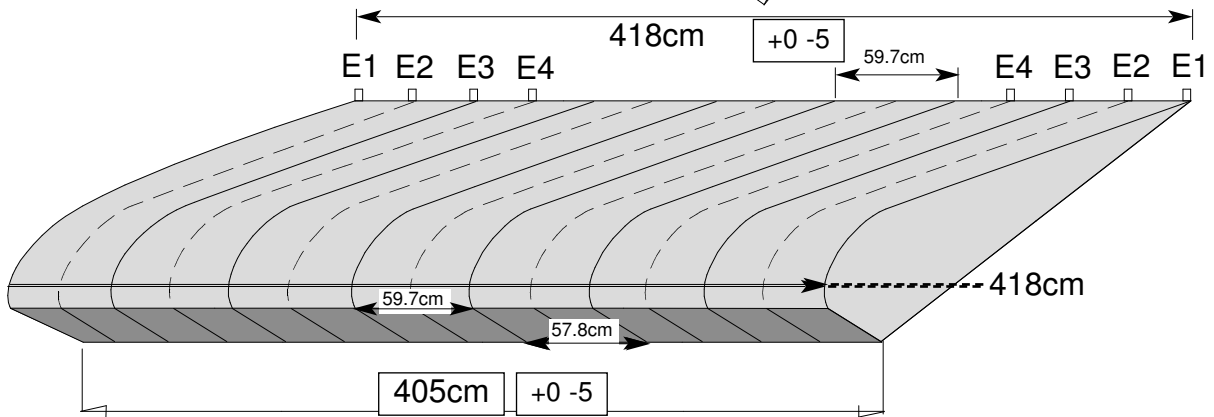
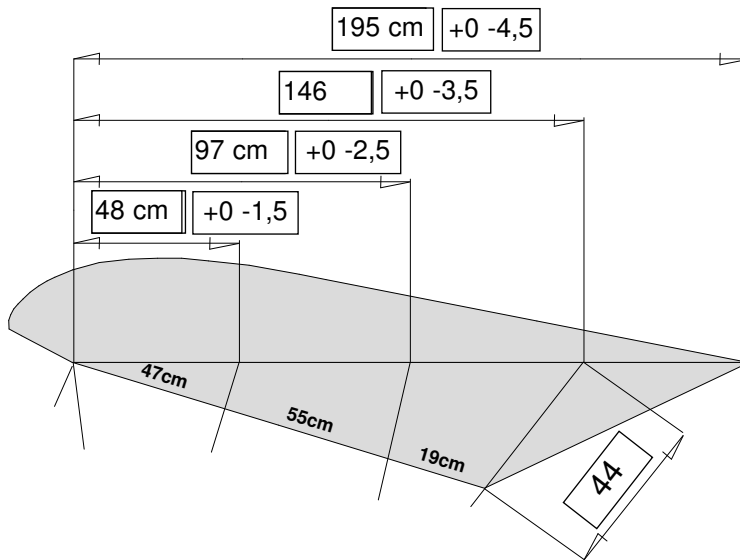
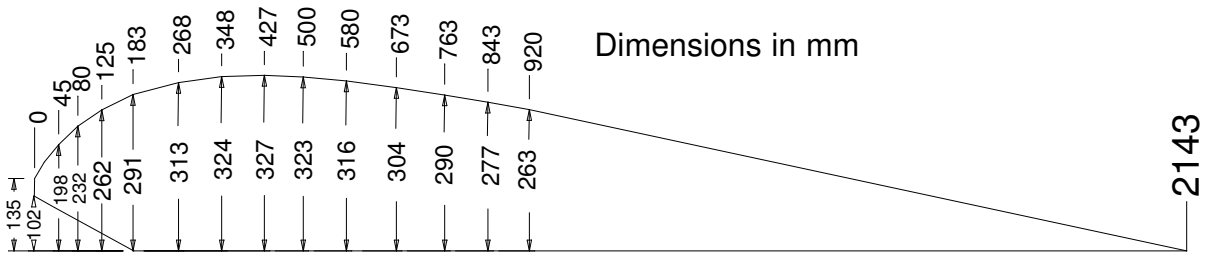

Drawn ADH	DATE 19/09/02	Tolerances ± 2	AERODYNE RESEARCH	
CHKD JLD	APPD AHD	DWG REV No.		
SCALE NTS	DIMENSIONS in cm			
TITLE: CANOPY RESERVE - 99 Ft²		DWG No.	VERSION	A4
FINAL CONTROL DOCUMENTS		P1482-01	PAGE 4	

REV	REVISIONS DETAILS	E.C.P.	DRN	APPN	DATE
A	Dimension 283 was 285cm	P/755/02	DM	ADH	12/11/02

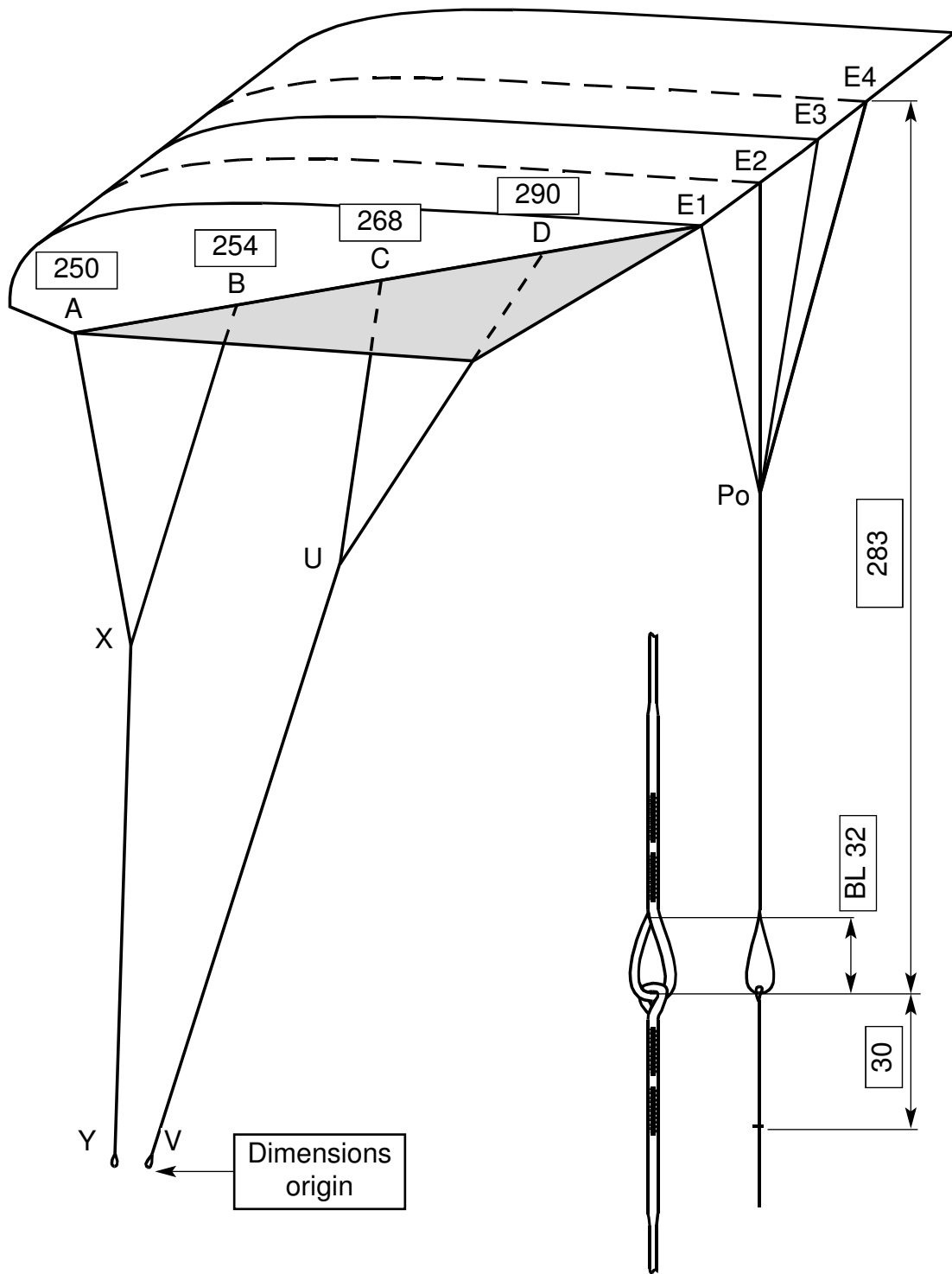

SLIDER PN: P1482-12

Drawn ADH	DATE 19/09/02	Tolerances ± 2	AERODYNE RESEARCH	
CHKD JLD	APPD AHD	DWG REV No. A		
SCALE NTS	DIMENSIONS in cm			
TITLE: CANOPY RESERVE - 110 Ft² FINAL CONTROL DOCUMENTS		DWG No. P1482-11	VERSION	A4
			PAGE 3	

REV	REVISIONS DETAILS	E.C.P.	DRN	APPN	DATE
-----	-------------------	--------	-----	------	------

AIRFOIL

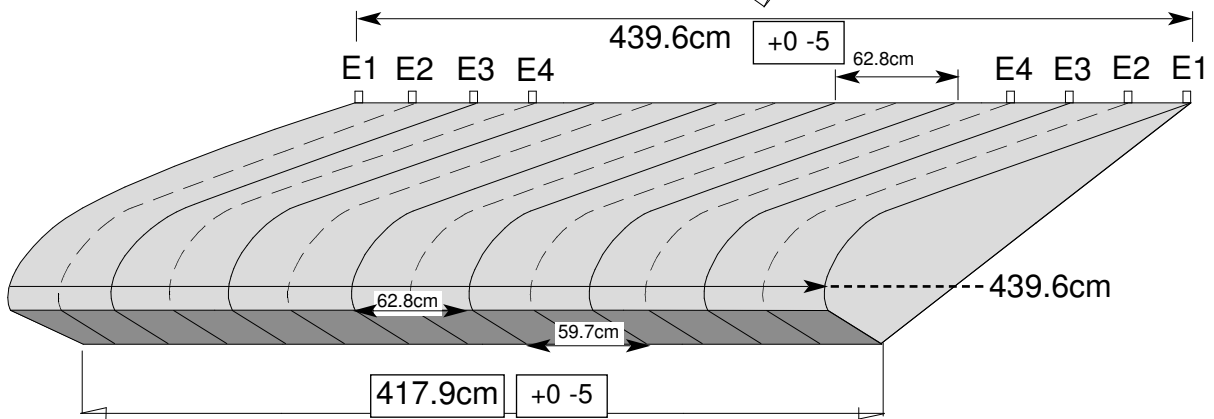
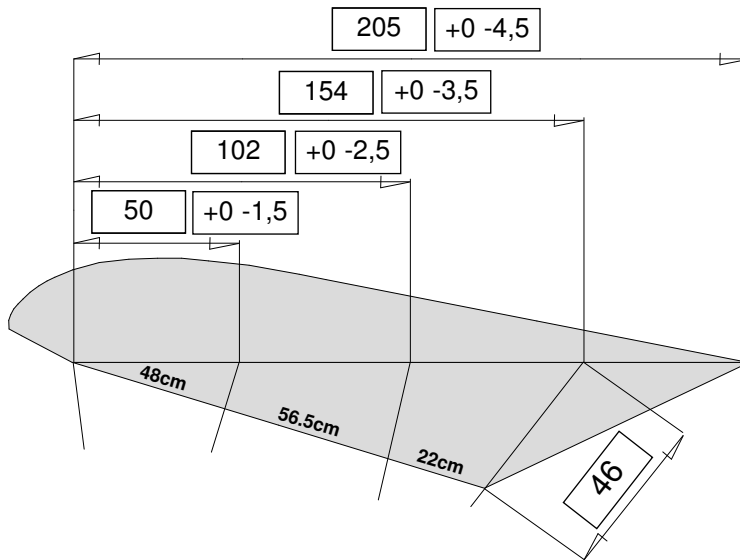
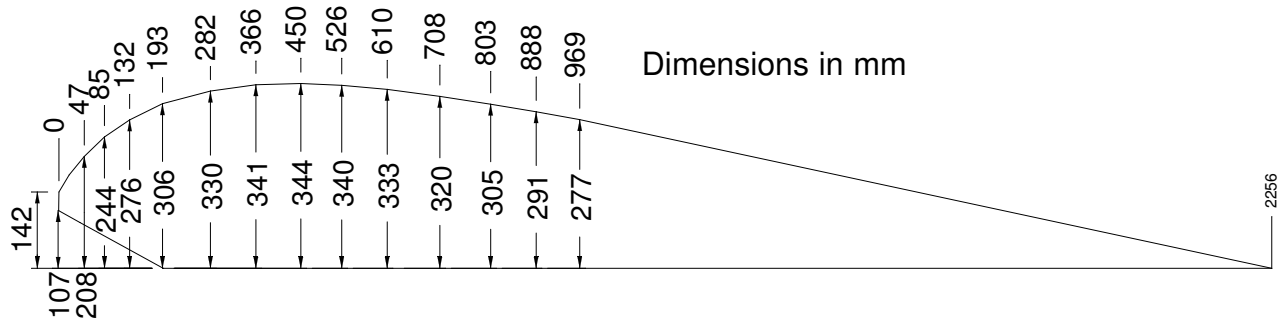

Drawn ADH	DATE 19/09/02	Tolerances ± 2	AERODYNE RESEARCH	
CHKD JLD	APPD AHD	DWG REV No.		
SCALE NTS	DIMENSIONS in cm			
TITLE: CANOPY RESERVE - 110 Ft² FINAL CONTROL DOCUMENTS		DWG No. P1482-11	VERSION	A4
			PAGE 4	

REV	REVISIONS DETAILS	E.C.P.	DRN	APPN	DATE
A	Dimension 295 was 297cm	P/755/02	DM	ADH	12/11/02

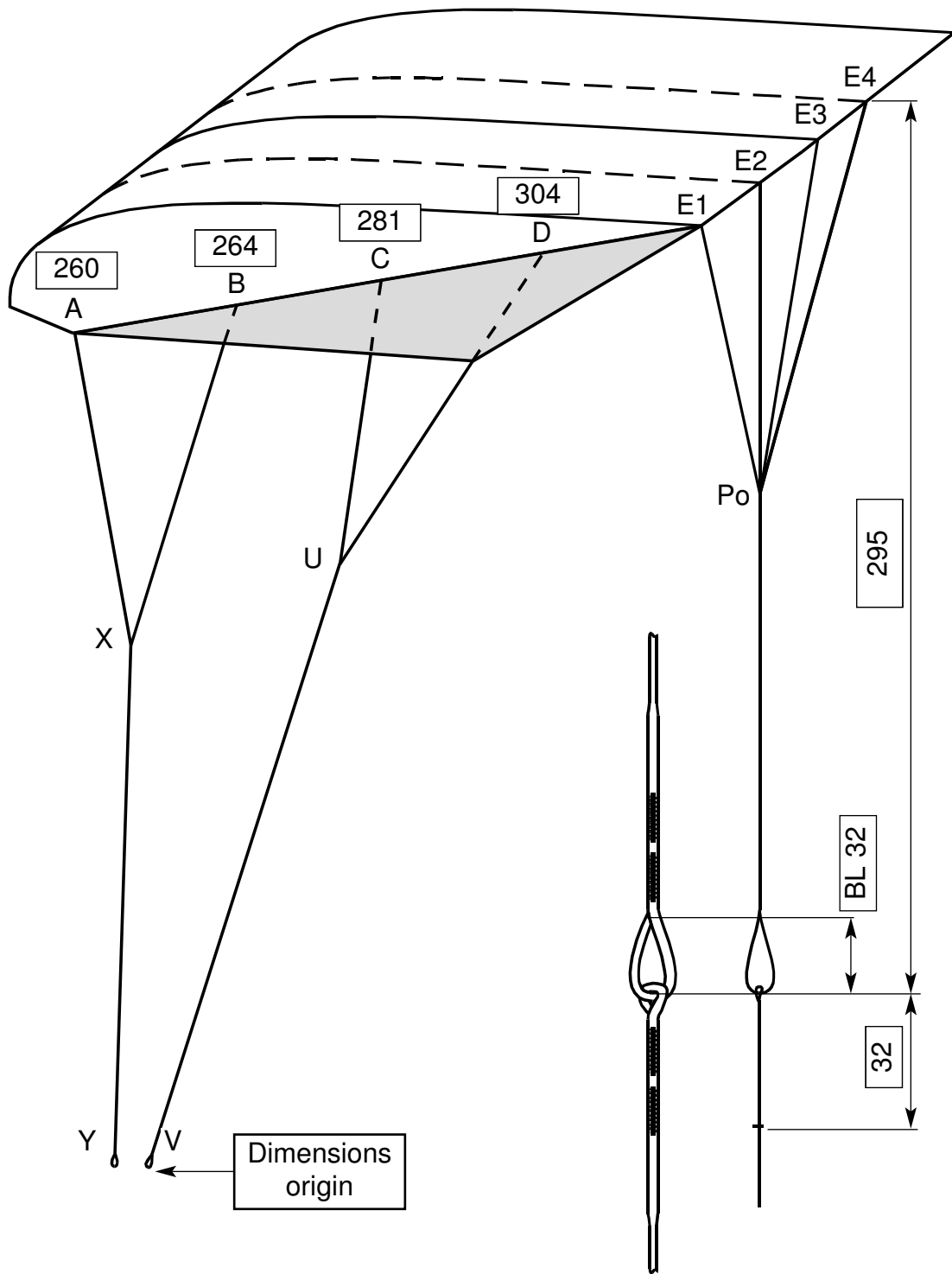

SLIDER PN: P1482-22

Drawn ADH	DATE 19/09/02	Tolerances ± 2	AERODYNE RESEARCH	
CHKD JLD	APPD AHD	DWG REV No. A		
SCALE NTS	DIMENSIONS in cm			
TITLE: CANOPY RESERVE - 120 Ft² FINAL CONTROL DOCUMENTS		DWG No. P1482-21	VERSION	A4
			PAGE 3	

REV	REVISIONS DETAILS	E.C.P.	DRN	APPN	DATE

AIRFOIL

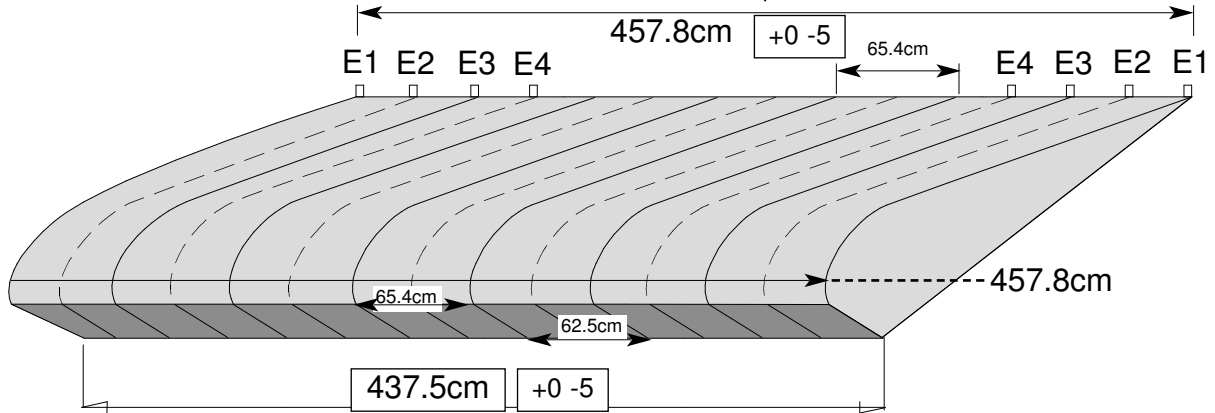
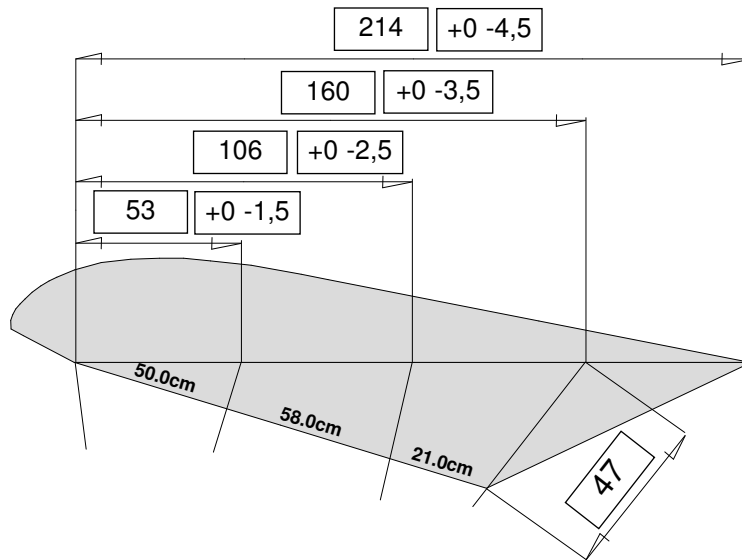
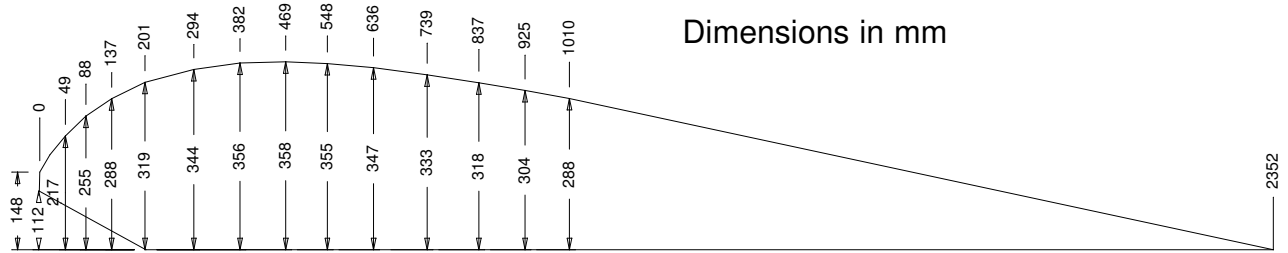

Drawn ADH	DATE 19/09/02	Tolerances +_ 2	AERODYNE RESEARCH	
CHKD JLD	APPD AHD	DWG REV No.		
SCALE NTS	DIMENSIONS in cm			
TITLE: CANOPY RESERVE - 120 Ft² FINAL CONTROL DOCUMENTS		DWG No. P1482-21	VERSION	A4
			PAGE 4	

REV	REVISIONS DETAILS	E.C.P.	DRN	APPN	DATE
A	Dimension 313 was 315cm	P/755/02	DM	ADH	12/11/02

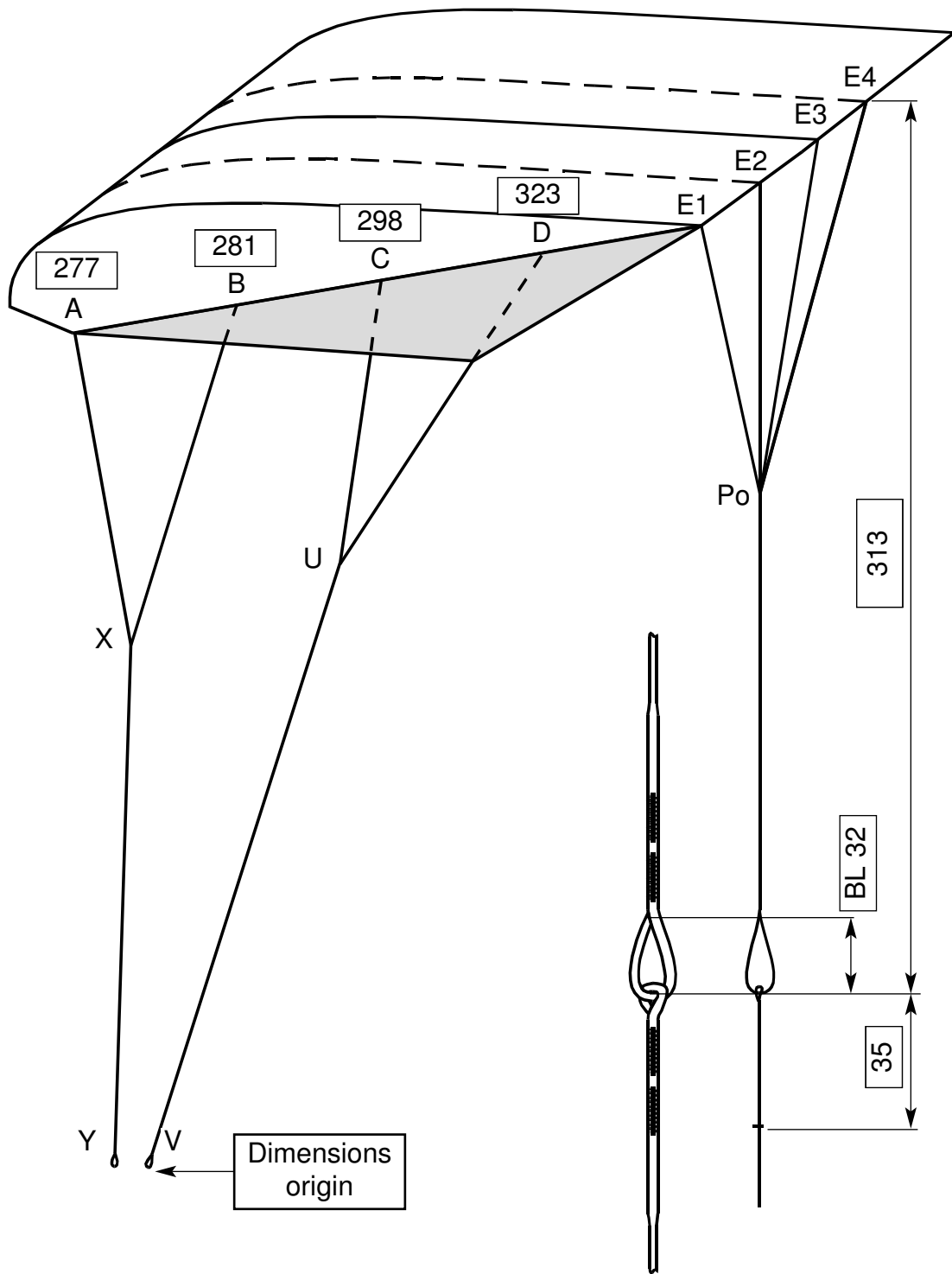

SLIDER PN: P1482-32

Drawn ADH	DATE 19/09/02	Tolerances ± 2	AERODYNE RESEARCH	
CHKD JLD	APPD AHD	DWG REV No. A		
SCALE NTS	DIMENSIONS in cm			
TITLE: CANOPY RESERVE - 135 Ft² FINAL CONTROL DOCUMENTS		DWG No. P1482-31	VERSION	A4
			PAGE 3	

REV	REVISIONS DETAILS	E.C.P.	DRN	APPN	DATE
-----	-------------------	--------	-----	------	------

AIRFOIL

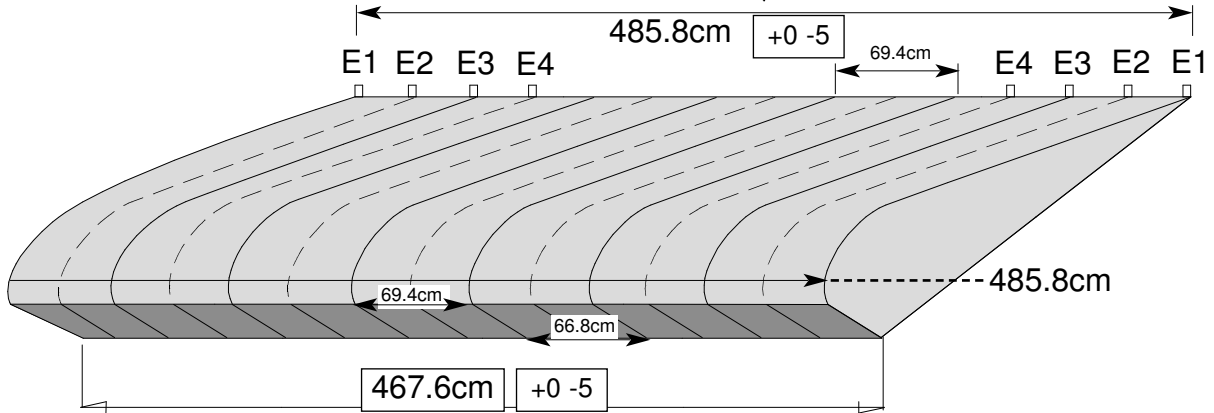
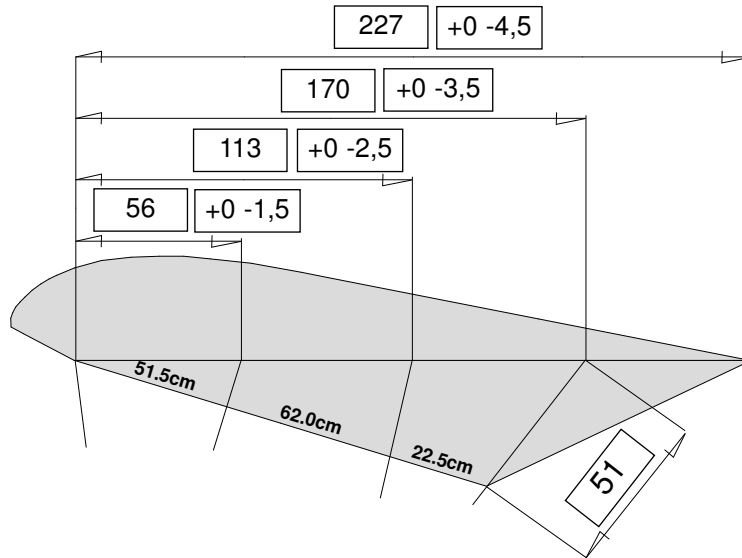
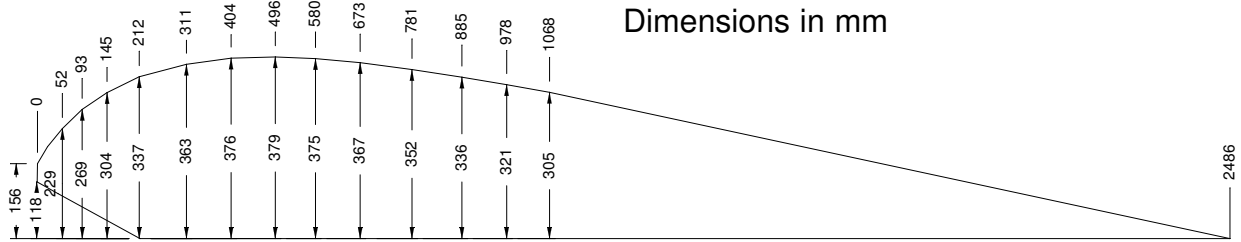

Drawn ADH	DATE 19/09/02	Tolerances ± 2	AERODYNE RESEARCH	
CHKD JLD	APPD AHD	DWG REV No.		
SCALE NTS	DIMENSIONS in cm			
TITLE: CANOPY RESERVE - 135 Ft² FINAL CONTROL DOCUMENTS		DWG No. P1482-31	VERSION	A4
			PAGE 4	

REV	REVISIONS DETAILS	E.C.P.	DRN	APPN	DATE
A	Dimension 340 & 328 were 314 & 332cm	P/755/02	DM	ADH	12/11/02

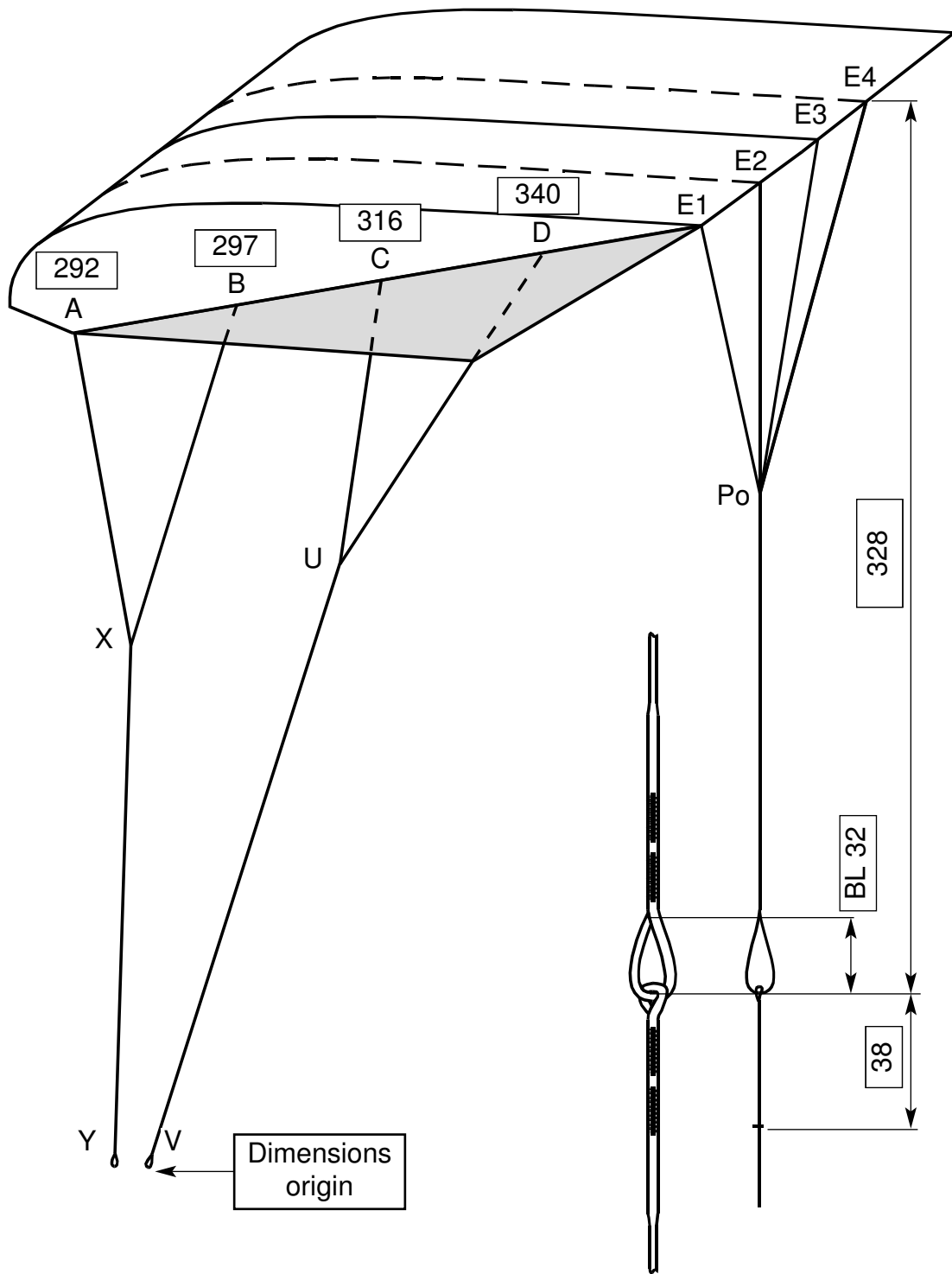

SLIDER PN: P1482-42

Drawn ADH	DATE 19/09/02	Tolerances ± 2	AERODYNE RESEARCH	
CHKD JLD	APPD AHD	DWG REV No. A		
SCALE NTS	DIMENSIONS in cm			
TITLE: CANOPY RESERVE - 150 Ft² FINAL CONTROL DOCUMENTS		DWG No. P1482-41	VERSION	A4
			PAGE 3	

REV	REVISIONS DETAILS	E.C.P.	DRN	APPN	DATE
-----	-------------------	--------	-----	------	------

AIRFOIL

Dimensions in mm

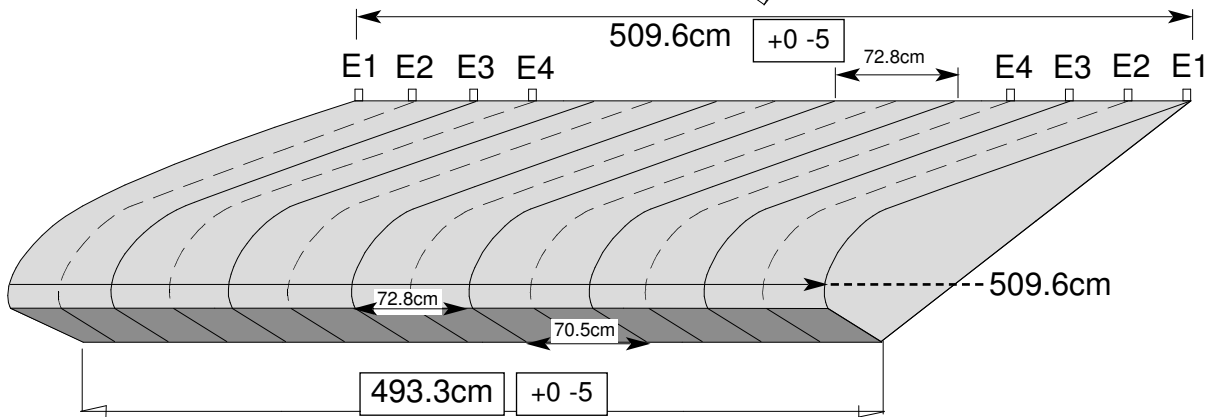
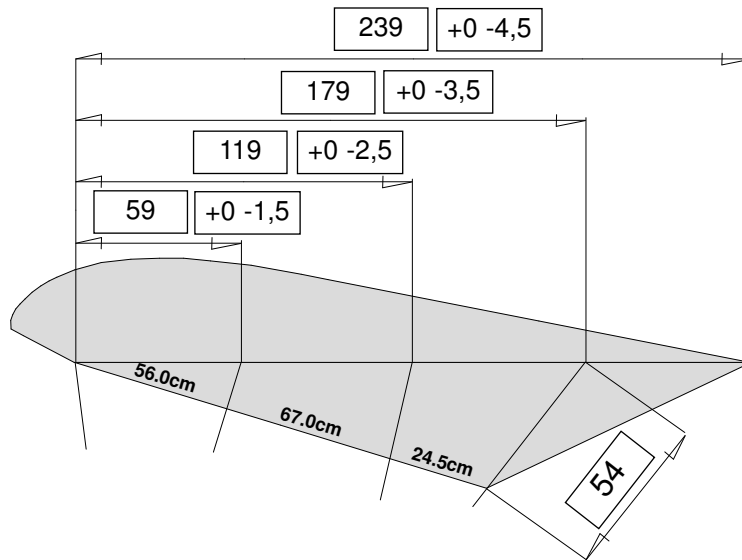
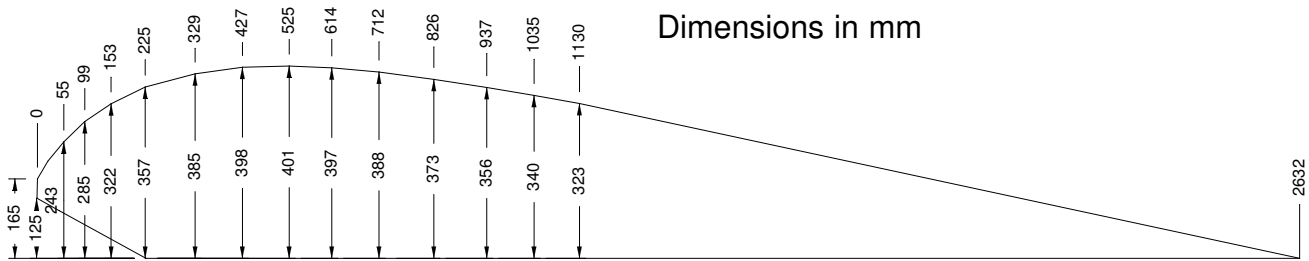

Drawn ADH	DATE 19/09/02	Tolerances ± 2	AERODYNE RESEARCH	
CHKD JLD	APPD AHD	DWG REV No.		
SCALE NTS	DIMENSIONS in cm			
TITLE: CANOPY RESERVE - 150 Ft² FINAL CONTROL DOCUMENTS		DWG No. P1482-41	VERSION	A4
			PAGE 4	

REV	REVISIONS DETAILS	E.C.P.	DRN	APPN	DATE

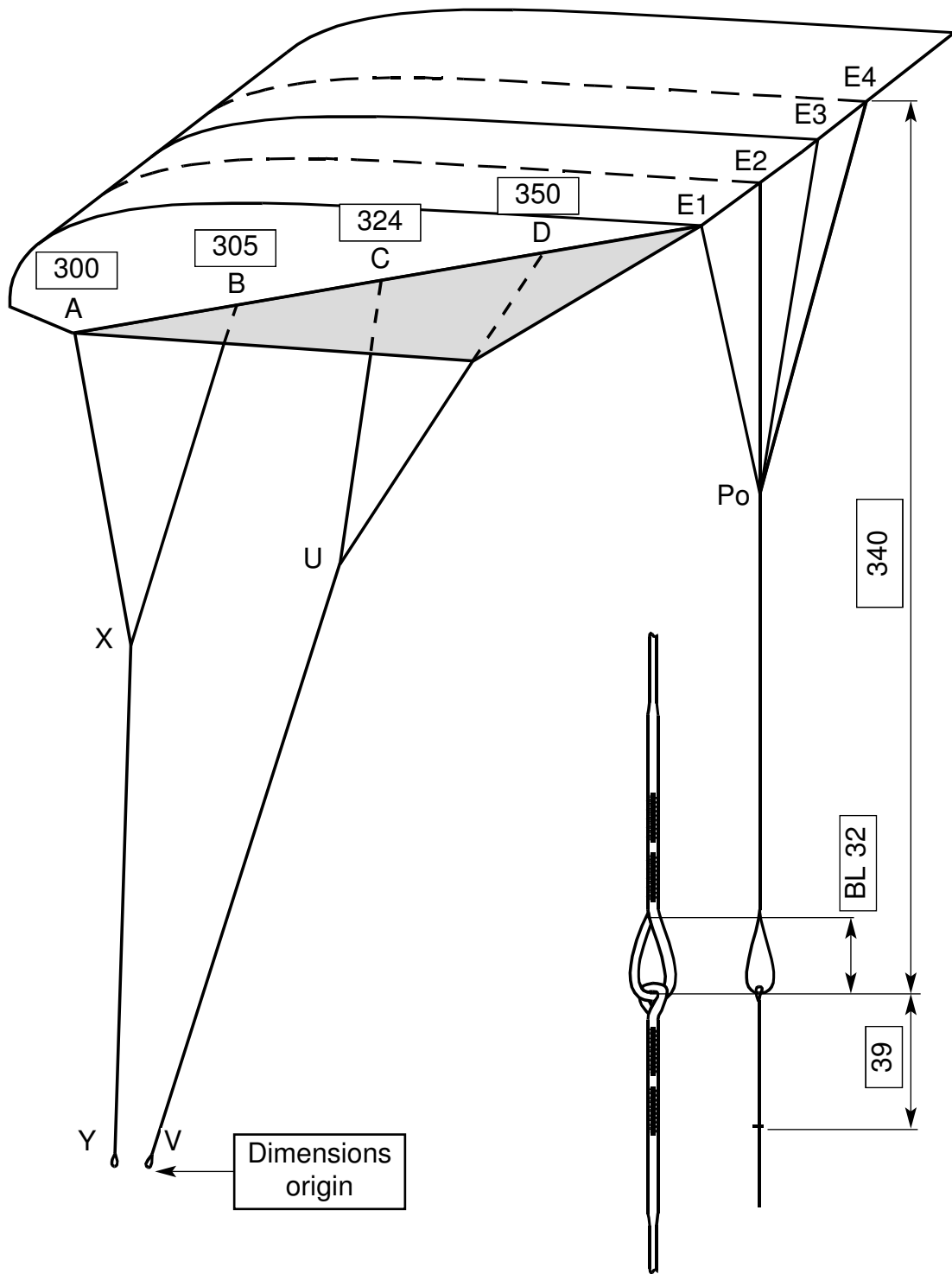

SLIDER PN: P1482-42

Drawn ADH	DATE 19/09/02	Tolerances ± 2	AERODYNE RESEARCH	
CHKD JLD	APPD AHD	DWG REV No.		
SCALE NTS	DIMENSIONS in cm			
TITLE: CANOPY RESERVE - 160 Ft² FINAL CONTROL DOCUMENTS		DWG No. P1482-51	VERSION	A4
			PAGE 3	

REV	REVISIONS DETAILS	E.C.P.	DRN	APPN	DATE
-----	-------------------	--------	-----	------	------

AIRFOIL

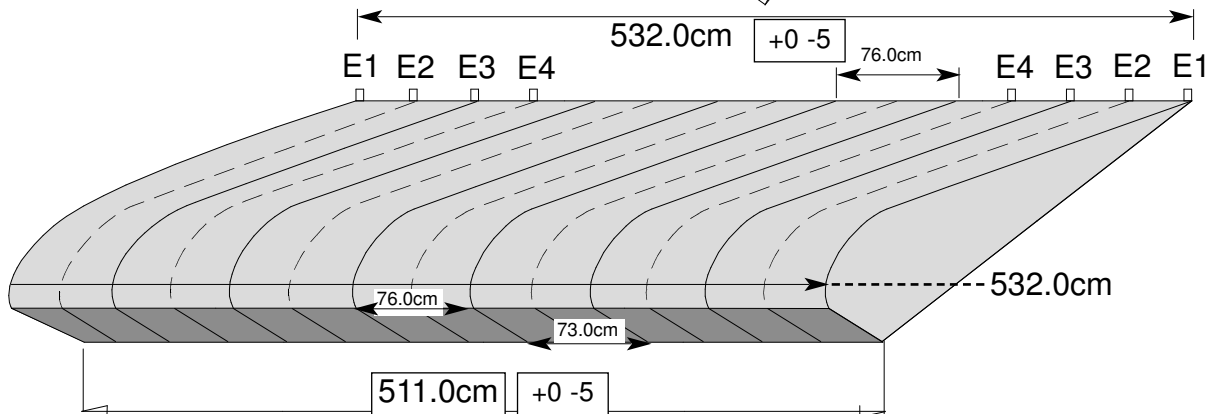
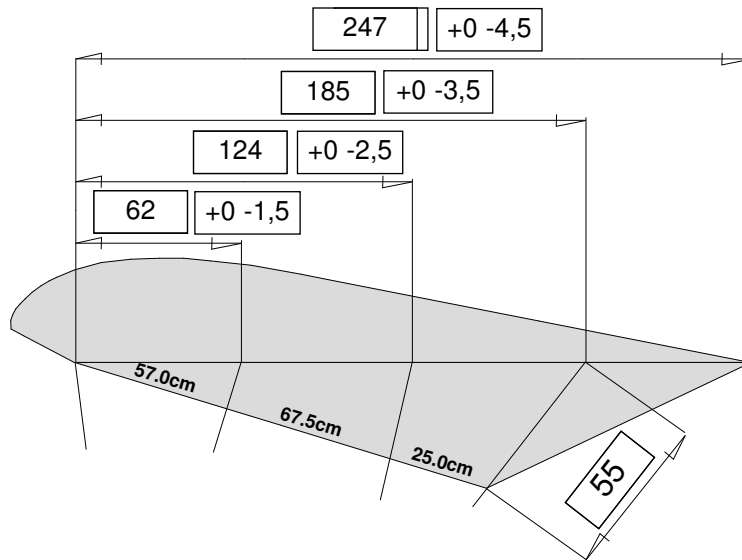
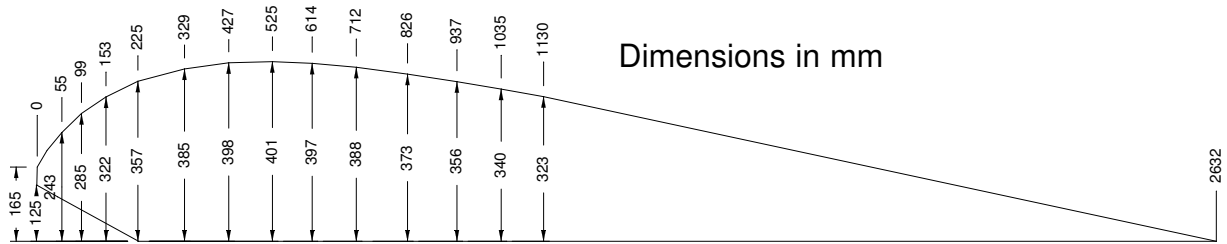

Drawn ADH	DATE 19/09/02	Tolerances ± 2	AERODYNE RESEARCH	
CHKD JLD	APPD AHD	DWG REV No.		
SCALE NTS	DIMENSIONS in cm			
TITLE: CANOPY RESERVE - 160 Ft² FINAL CONTROL DOCUMENTS		DWG No. P 1482-51	VERSION	A4
			PAGE 4	

REV	REVISIONS DETAILS	E.C.P.	DRN	APPN	DATE
A	Dimension 352 was 355cm	P/755/02	DM	ADH	12/11/02

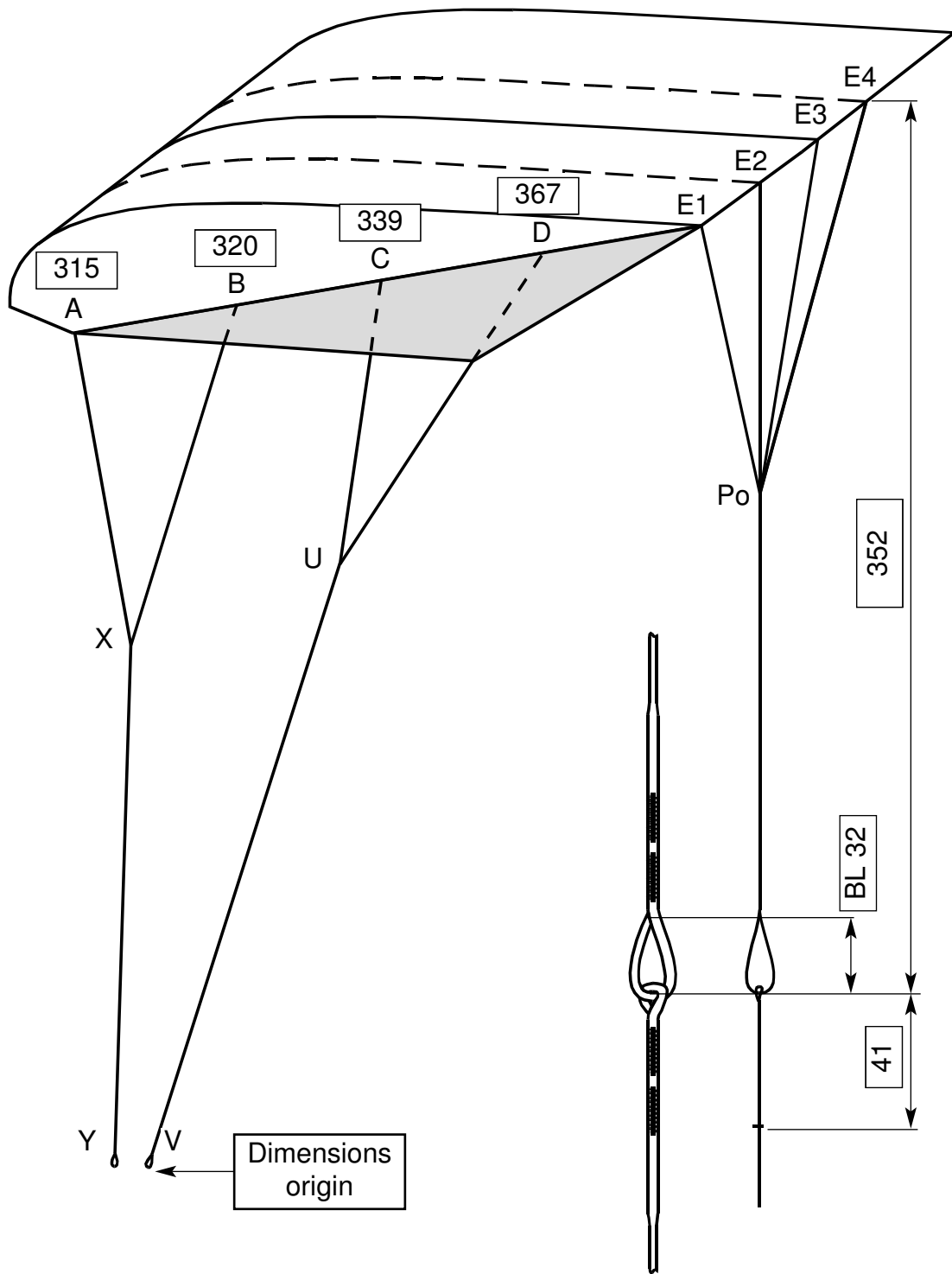

SLIDER PN: P1482-42

Drawn ADH	DATE 19/09/02	Tolerances ± 2	AERODYNE RESEARCH	
CHKD JLD	APPD AHD	DWG REV No. A		
SCALE NTS	DIMENSIONS in cm			
TITLE: CANOPY RESERVE - 175 Ft² FINAL CONTROL DOCUMENTS		DWG No. P1482-61	VERSION	A4
			PAGE 3	

REV	REVISIONS DETAILS	E.C.P.	DRN	APPN	DATE
-----	-------------------	--------	-----	------	------

AIRFOIL

Dimensions in mm

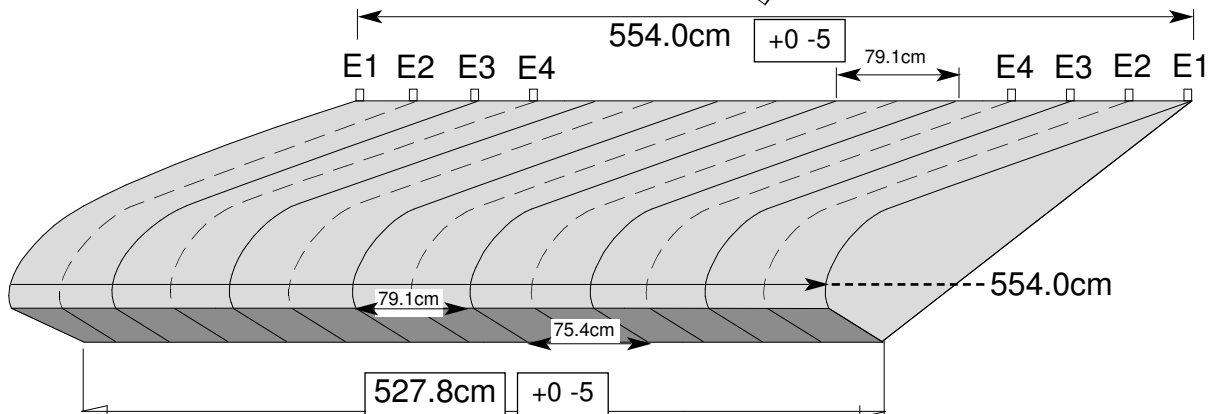
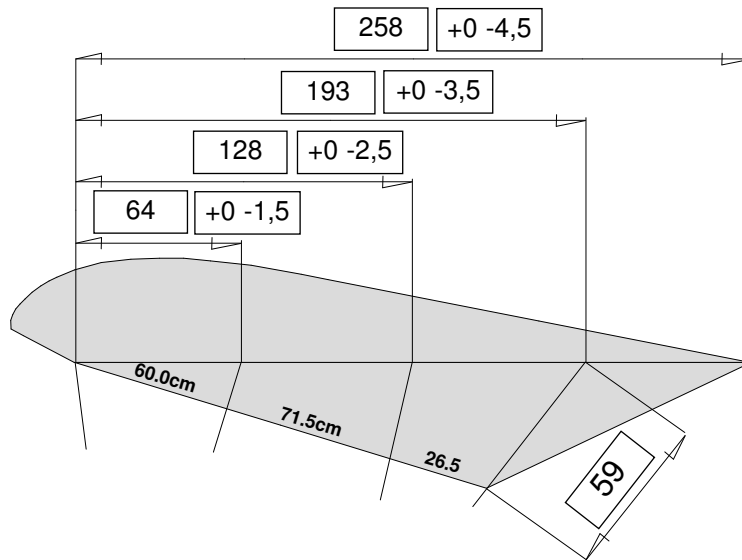
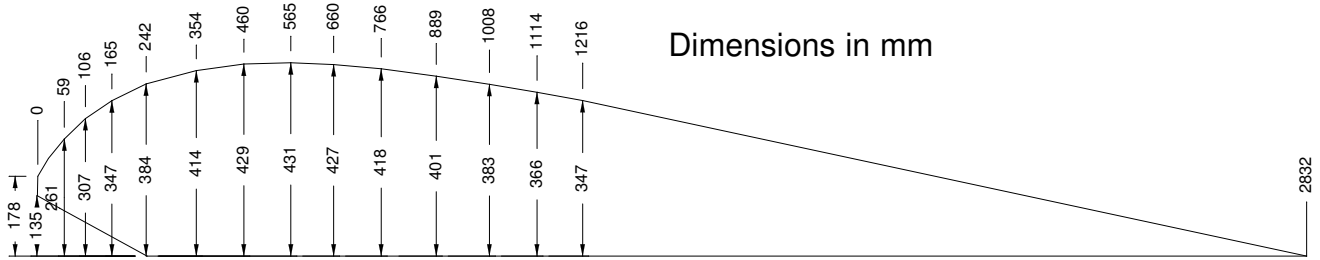

Drawn ADH	DATE 19/09/02	Tolerances ± 2	AERODYNE RESEARCH	
CHKD JLD	APPD AHD	DWG REV No.		
SCALE NTS	DIMENSIONS in cm			
TITLE: CANOPY RESERVE - 175 Ft² FINAL CONTROL DOCUMENTS		DWG No. P1482-61	VERSION	A4
			PAGE 4	

REV	REVISIONS DETAILS	E.C.P.	DRN	APPN	DATE
A	Dimension 367 was 370cm	P/755/02	DM	ADH	12/11/02

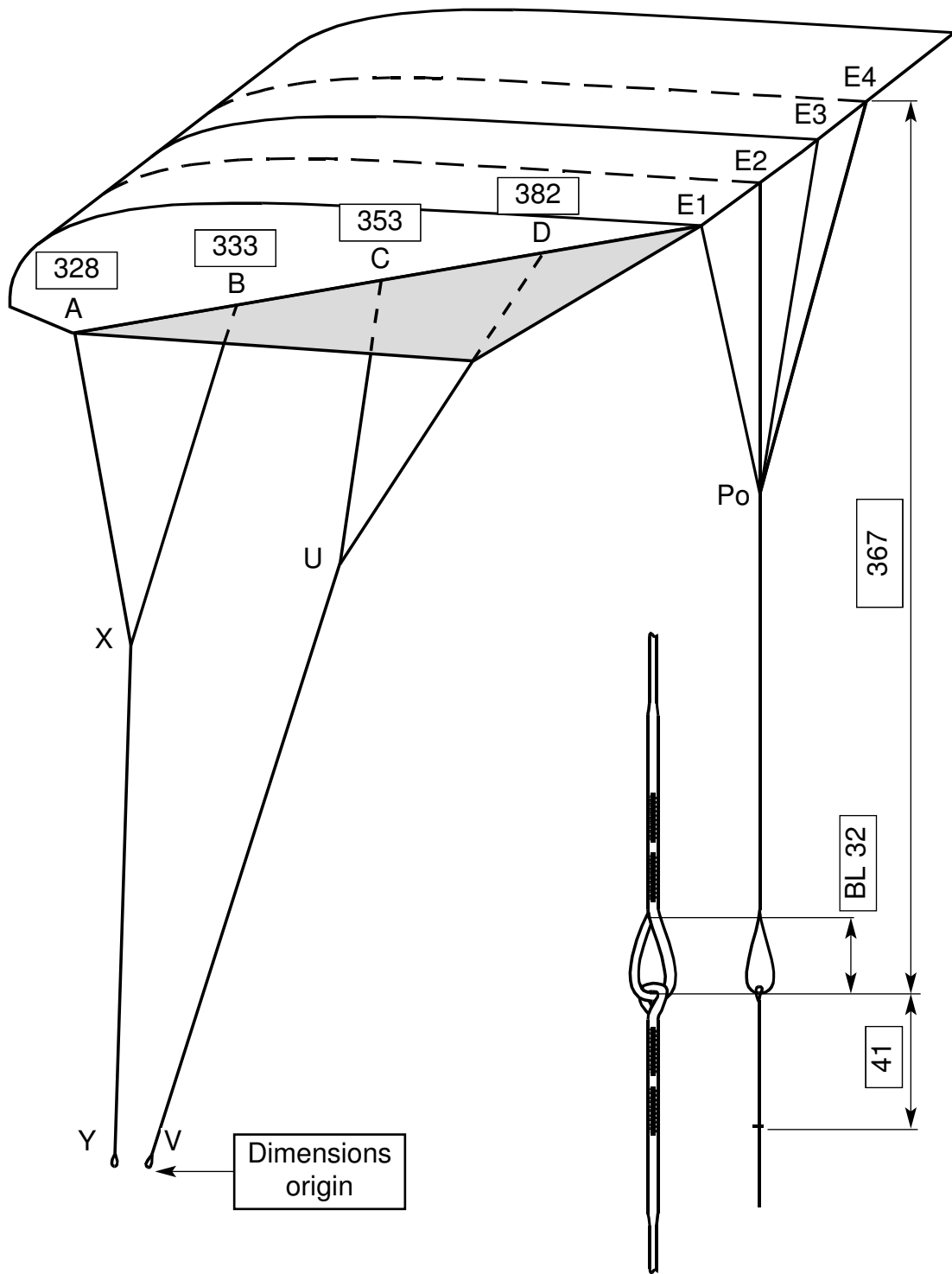

SLIDER PN: P1482-72

Drawn ADH	DATE 19/09/02	Tolerances ± 2	AERODYNE RESEARCH	
CHKD JLD	APPD AHD	DWG REV No. A		
SCALE NTS	DIMENSIONS in cm			
TITLE: CANOPY RESERVE - 190 Ft² FINAL CONTROL DOCUMENTS		DWG No. P1482-71	VERSION	A4
			PAGE 3	

REV	REVISIONS DETAILS	E.C.P.	DRN	APPN	DATE

AIRFOIL

Dimensions in mm

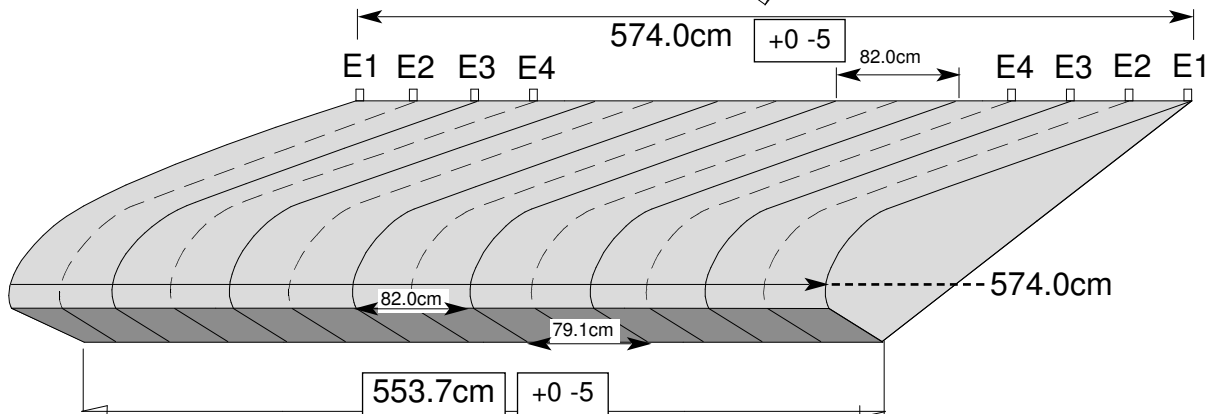
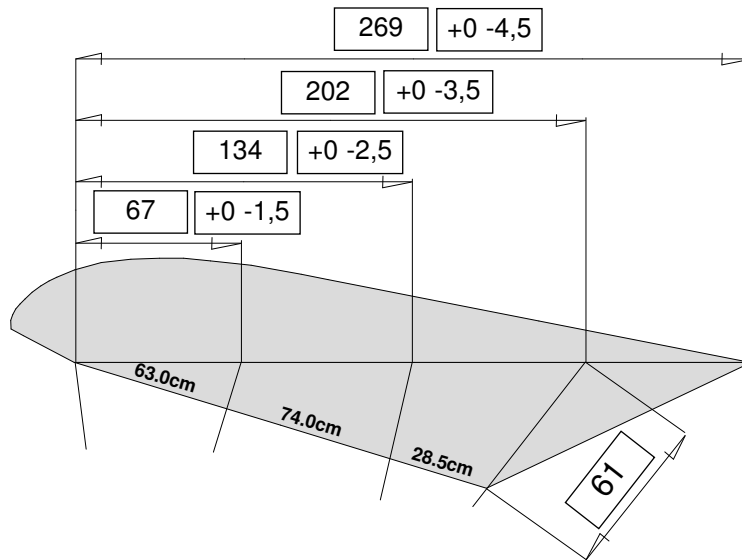
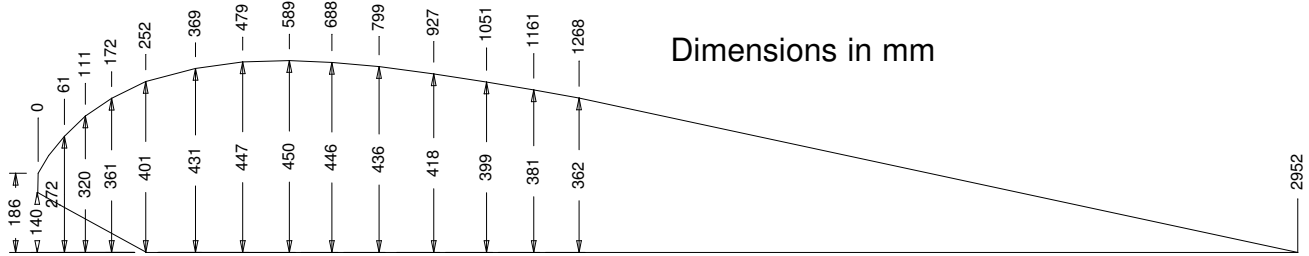

Drawn ADH	DATE 19/09/02	Tolerances ± 2	AERODYNE RESEARCH	
CHKD JLD	APPD AHD	DWG REV No.		
SCALE NTS	DIMENSIONS in cm			
TITLE: CANOPY RESERVE - 190 Ft² FINAL CONTROL DOCUMENTS		DWG No. P1482-71	VERSION	A4
			PAGE 4	

REV	REVISIONS DETAILS	E.C.P.	DRN	APPN	DATE
A	Dimension 382 was 384cm	P/755/02	DM	ADH	12/11/02

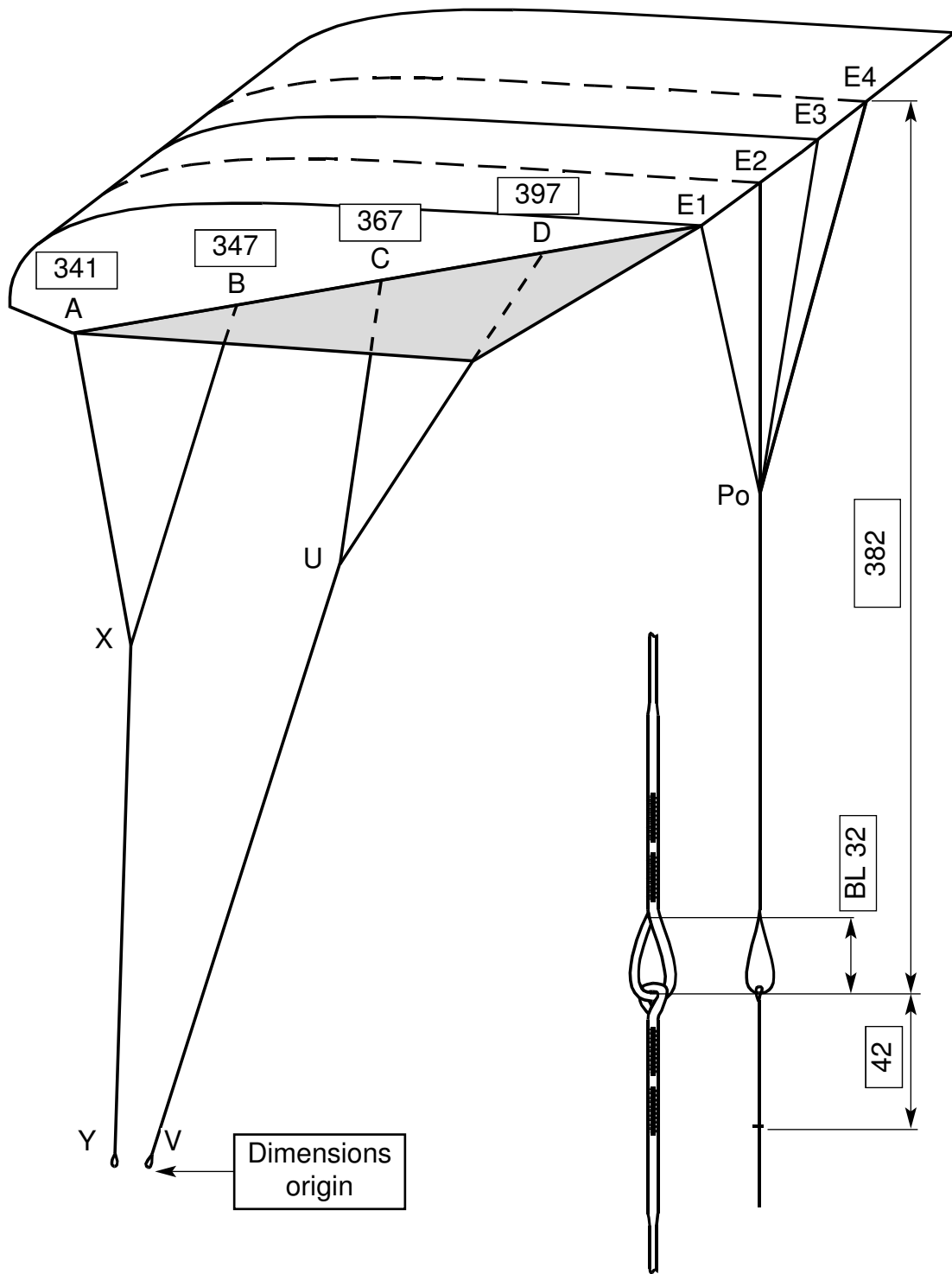

SLIDER PN: P1482-72

Drawn ADH	DATE 19/09/02	Tolerances ± 2	AERODYNE RESEARCH	
CHKD JLD	APPD AHD	DWG REV No. A		
SCALE NTS	DIMENSIONS in cm			
TITLE: CANOPY RESERVE - 220 Ft² FINAL CONTROL DOCUMENTS		DWG No. P1482-81	VERSION	A4
			PAGE 3	

REV	REVISIONS DETAILS	E.C.P.	DRN	APPN	DATE
-----	-------------------	--------	-----	------	------

AIRFOIL

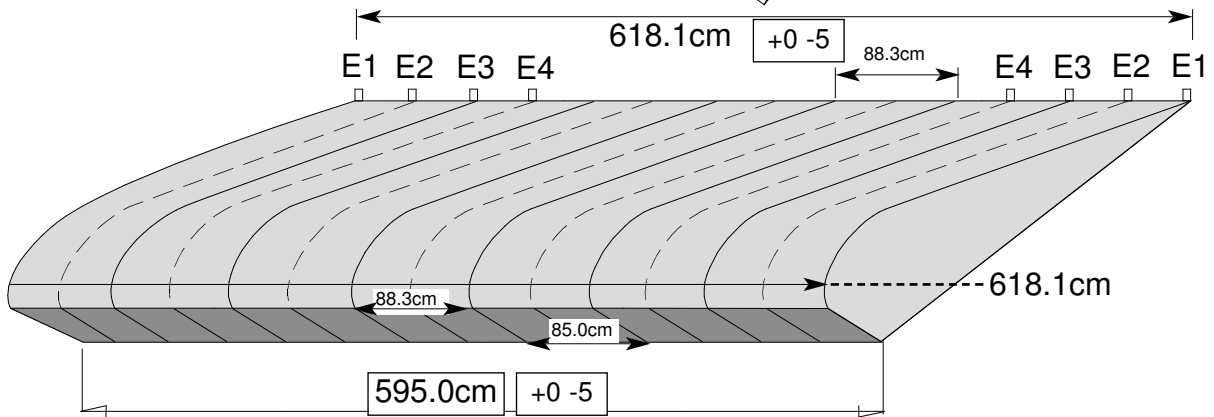
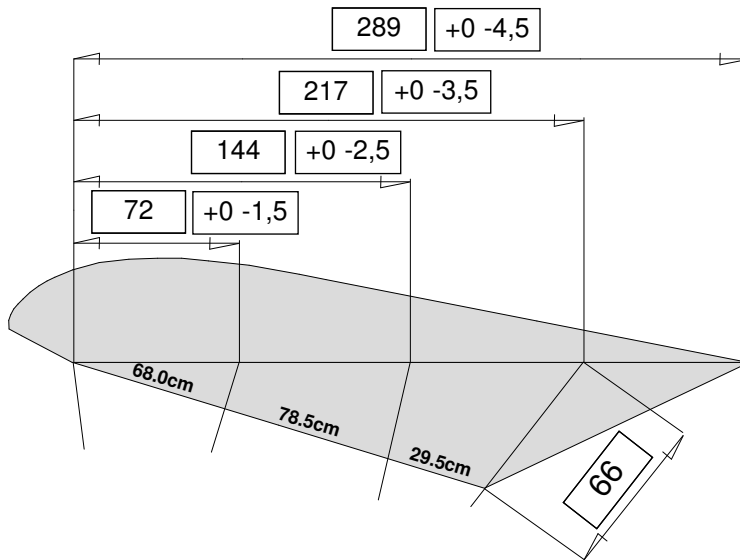
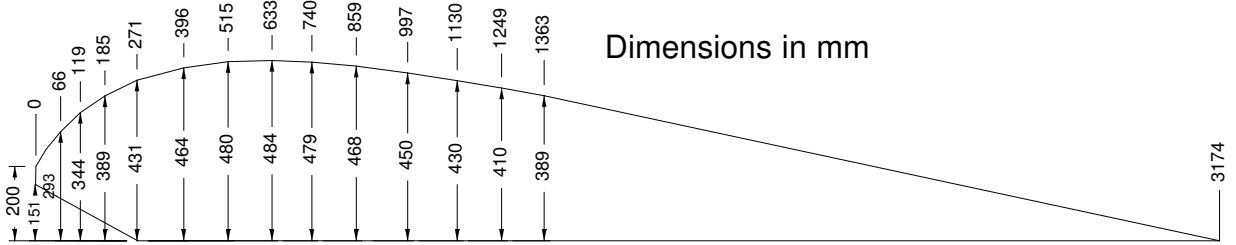

Drawn ADH	DATE 19/09/02	Tolerances ± 2	AERODYNE RESEARCH	
CHKD JLD	APPD AHD	DWG REV No.		
SCALE NTS	DIMENSIONS in cm			
TITLE: CANOPY RESERVE - 220 Ft² FINAL CONTROL DOCUMENTS		DWG No. P1482-81	VERSION	A4
			PAGE 4	

REV	REVISIONS DETAILS	E.C.P.	DRN	APPN	DATE
A	Dimension 417 was 419cm	P/755/02	DM	ADH	12/11/02

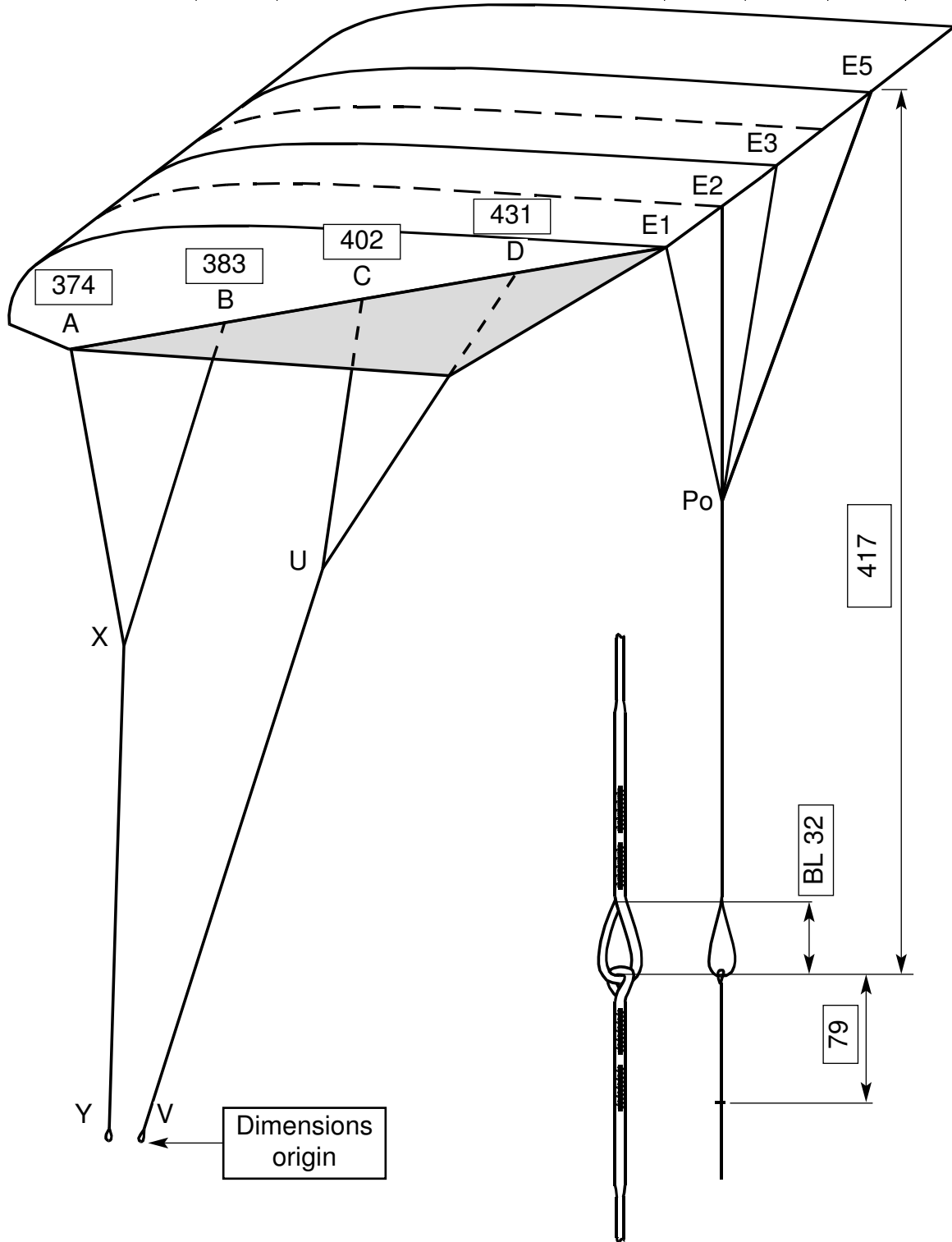

SLIDER PN: P1483-02

Drawn ADH	DATE 19/09/02	Tolerances ± 2	AERODYNE RESEARCH
CHKD JLD	APPD AHD	DWG REV No. A	
SCALE NTS	DIMENSIONS in cm		
TITLE: CANOPY RESERVE - 250 Ft² FINAL CONTROL DOCUMENTS		DWG No. P1483-01	VERSION A4
			PAGE 5 of 6

REV	REVISIONS DETAILS	E.C.P.	DRN	APPN	DATE
-----	-------------------	--------	-----	------	------

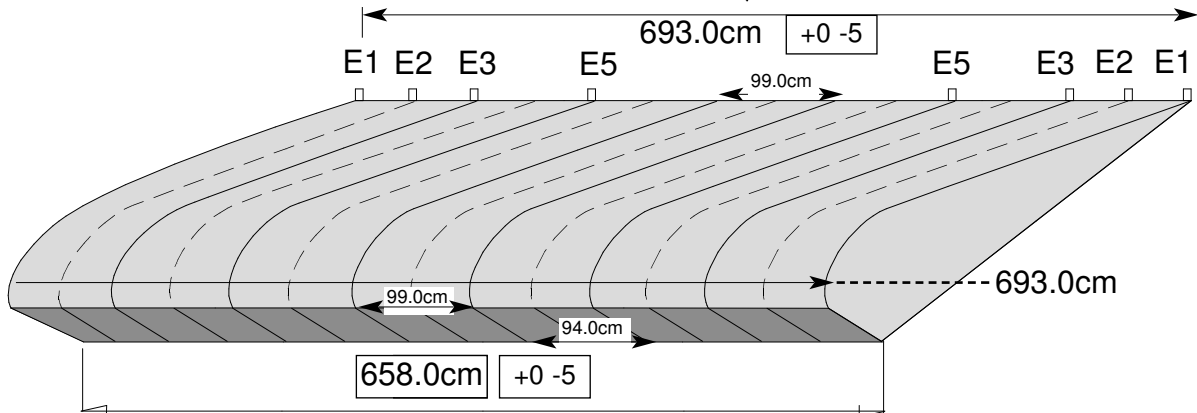
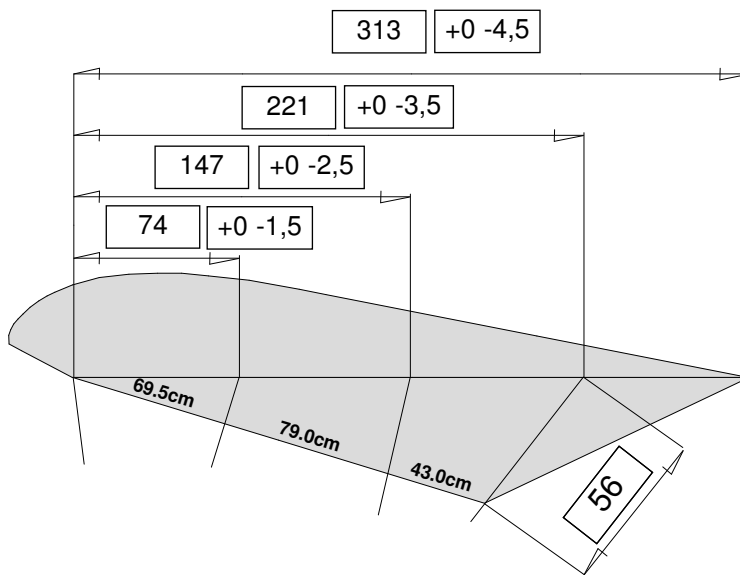
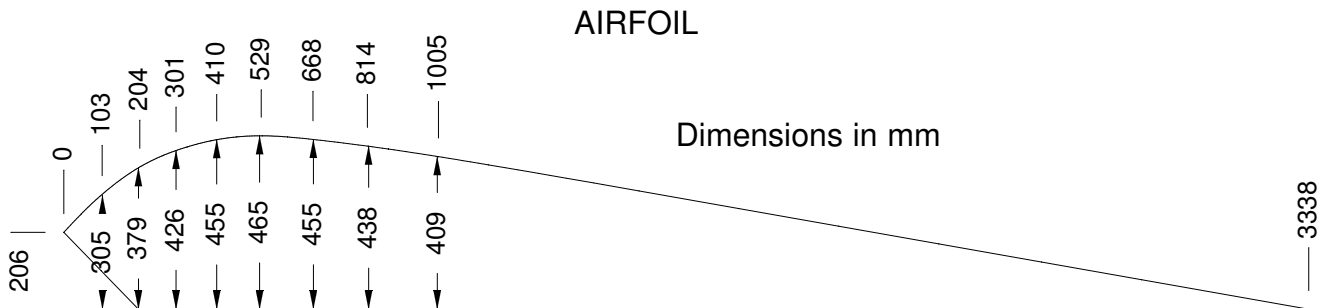

Drawn ADH	DATE 19/09/02	Tolerances ± 2	AERODYNE RESEARCH	
CHKD JLD	APPD AHD	DWG REV No.		
SCALE NTS	DIMENSIONS in cm			
TITLE: CANOPY RESERVE - 250 Ft² FINAL CONTROL DOCUMENTS		DWG No. P1483-01	VERSION	A4
			PAGE 6 of 6	